



# THE ONTARIO NUMISMATIST

OFFICIAL PUBLICATION OF THE ONTARIO NUMISMATIC ASSOCIATION

ISSN 0048-1815

1991-1993

## O.N.A. OFFICERS

Immediate Past President  
K. Wilmot

President  
G. Oblinski

First Vice President  
R. Zelk

Second Vice President  
Vacant

Secretary  
E. Dezo

Treasurer & Membership  
B. H. Raszmann  
Box 33, Waterloo, N2J 3Z6

### Directors:

Area: 1a T. Kostaluk  
1b S. Hodge  
2 T. Masters  
3 R. Voaden  
4 R. Fletcher  
5 K. Wilmot  
6 E. Workman  
7 H. Farrow  
8 B. Watt  
9 B. Uman  
10 R. Albert

### Head Judge

E. Workman  
R. R. #2 Cannington, Ont.  
LOE 1EO

### Speakers Circuit & Convention Co-Ordinator

T. Kennedy

### Audio-Visual Service

K. Koch  
219 Southwood Drive  
Kitchener, Ont. N2E 2B2

### Editor-Librarian

T. Masters  
823 Van Street  
London, Ont. N5Z 1M8

VOLUME 32

JANUARY-FEBRUARY ISSUE

PAGE 1- 93

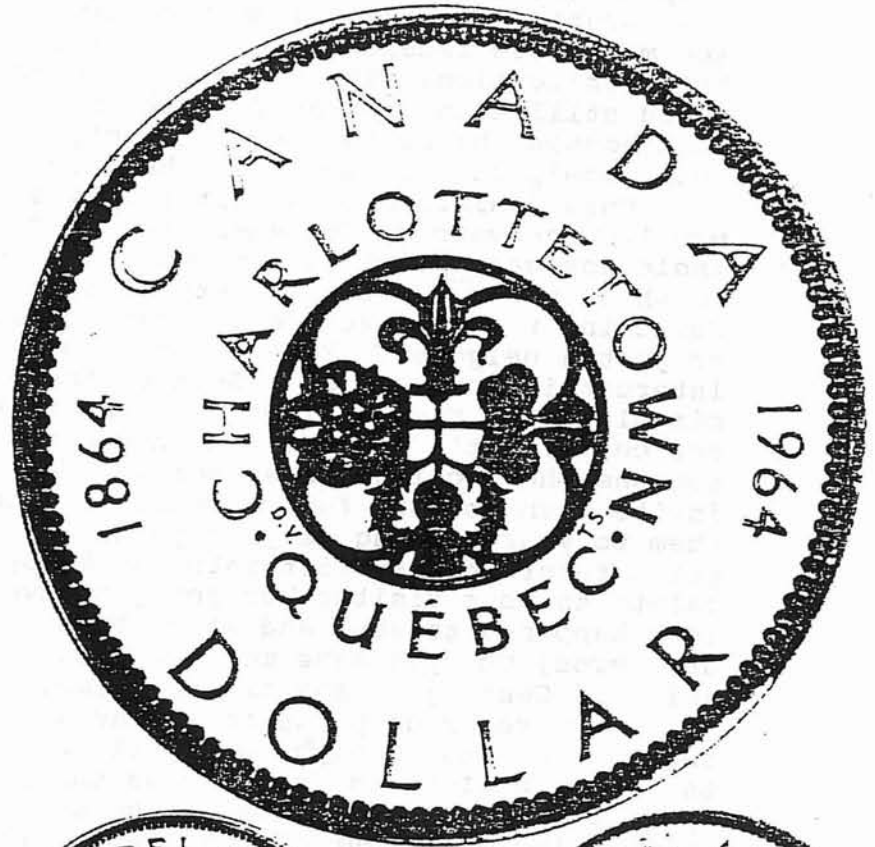

The ONTARIO NUMISMATIST is published by the Ontario Numismatic Association. The publication can be obtained with membership in one of the following categories: Regular Membership \$10.00 annually; Husband & Wife (one journal) \$12.00 annually; Junior (up to 18) \$3.00 annually. Life Memberships available for \$100.00 after 3 years of regular membership. Club Membership \$15.00. Remittances payable to the Ontario Numismatic Assoc. P.O. Box 33, Waterloo, Ont. N2J 3Z6



You often wonder, when you prepare the issue of the O.N.A. Numismatist, if anyone ever reads it....

In our last issue, I discussed the problem of more than one Coin Show scheduled on the same day, and the problems that could and did result. I asked for Club and individuals for their help in getting their Club dates to me, so we could help to alleviate that problem. To date I have received most of the Show dates for Ontario and most were received by mail. It just proves that someone does read this publication. Thanks to all who submitted their Show notices. I would still like to hear from the following Clubs....Oshawa & District, Collingwood, Waterloo, and there may be others. If you are reading this...help me out, so we can help you too.

Coin dealers report that 1992 was a good year, mainly due to the new 125 Anniversary Commemorative 25 Cents. The Mint has introduced a whole new generation to numismatics...it's up to us now to follow up on those we know received sets of these coins. At Christmastime these new coins were a favorite present for some son, daughter, grandchild, or just a neighbor. Many of these people had no or very little previous interest in numismatics. Some of those coins will find their way into circulation. Many will be put away as keepsakes. The ball is now in our court...it's up to us to return the serve. I'm sure we all know of someone who received these coins. Tell them about your Coin Club.... invite them to your future meeting....better still pick them up and take them to your meeting as your guest. Sometimes that's all it takes to get a future numismatist into the hobby. On your way to the meeting relate to your visitor how you got involved, some interesting events that happened to you, and also about some of the characters (good... of course) who you have met and become involved with. Those Commemorative 25 Cents just may be the stimulant our hobby has needed!

Have you made plans to attend this year's O.N.A. Convention at the College Inn, Guelph, on April 16-18? Here's a way to be introduced to fellow collectors from across the province. It also gives you the opportunity to acquire some of those illusive coins that are not normally included in your club auction. There is a variety of programs being offered with you, the collector, in mind. Some of those include the Educational Forum, Delegates Breakfast, O.N.A. Election of Officers for 1993-95, and the O.N.A. General Meeting.

Have you ever thought of becoming an O.N.A. Executive Member? There is room for new blood and new ideas on that Executive. You could be that person that the O.N.A. needs. Think about it! And act upon it, too!!!

Let's finish off these rambling thoughts with a few observations..

The O.N.A., for a number of years, have been asking Clubs to host their Convention. Little or no response! Perhaps the O.N.A. should consider a permanent location if no other offers are available?

For those who say a clique runs the O.N.A., offer your services to break up that said clique. (I'm sure those on the O.N.A. Executive are dedicated people and don't deserve the clique label).

The O.N.A. has invested a large amount of money in their library, but it's not being used to its full potential. (many say cost of borrowing too high...borrower pays postage both ways. O.N.A. has no control over postal rates).

The Royal Canadian Mint had a very inexpensive 125 Commemorative program for 1992. What are their plans for a future program with the collector in mind? (Many collectors have been turned off by some

.....

FROM THE EDITOR'S CHAIR (Cont'd)

previous programs...e.g. Olympics- gold, and others.

There are other thoughts (mine) I could share with you, but for now these will do. Whether you agree or disagree with these thoughts is your prerogative. Drop me a line with your thoughts. I'll publish our letter if permission is given.

For now...let's keep numismatics alive!! I CHALLENGE YOU TO DO YOUR PART!!!!

T. Masters

\*\*\*\*\*

## **ASSOCIATION NEWS**

### MEMBERSHIP

The following applications have been received. If no written objection to these applications are received, acceptance will appear in the next issue of the Ontario Numismatist.

- |      |                    |                      |
|------|--------------------|----------------------|
| 1346 | Hugh Powell        | Kenora, Ontario      |
| 1347 | Guntram Weisbrich  | Calgary, Alberta     |
| 1348 | Craig Wilde        | Thunder Bay, Ontario |
| 1349 | Gary L. Schlemmer  | Valencia, PA. U.S.A. |
| 1350 | Albert Bissonnette | Lansdowne, Ontario   |

Editor's Note: The first two names on this list of new members should have been published in our November-December issue. This was an oversight on the Editor's part and not that of our Membership Chairperson Bruce Raszmann.

Anyone knowing the current address for:

882 Terrence E. Frost Ottawa, Ontario

Please contact the O.N.A., P.O. Box 33, Waterloo, Ontario, N2J 3Z6. The Ontario Numismatist for Mr. Terrence E. Frost has been returned.

\*\*\*\*\*

### CONVENTION UPDATE:....

At the time of this writing, the Official O.N.A. Medal has not been received from Pressed Metal Products, in Vancouver B.C. This medal will feature the City of Guelph's most outstanding landmark - "The Church of Our Lady".

A limited quantity of these medals are being struck, and should be sold out at a very early date. The amount being struck are as follows:

- 40 sterling silver - 100 bronze - 60 gold plate

The 60 gold plate are not for sale but will be included in the first 60 Pre-Registration Packs. Order forms and prices for Pre-Registration will be included in our next issue.

I haven't received notification on how many persons our Saturday Night Banquet will be limited to, but expect these tickets will be sold fast. Banquet Speaker is Rev. Roger McCombe, and for those who have never heard this man speak before, you are in for a treat. His humour far outweighs most professional comedians that we see on TV today. I'm sure that after hearing Roger you will say it was one of the highlights of the Convention.

\*\*\*\*\*

# CANADA'S CHARLOTTETOWN DOLLAR

by H.R.G. Currie



On a cold, windy day in September, 1864, a little ship crossed the Straits of Northumberland from the colony of New Brunswick, and dropped anchor near Charlottetown in the sister colony of Prince Edward Island. A small boat rowed several visitors ashore, one at a time. Among them was my great, great grandfather's first cousin. I can imagine that humorous sight--the tall, spare

politician from Upper Canada, clad in frock coat and tall hat, holding on for dear life as the boat bobbed in the choppy sea.

He and his colleagues from Upper and Lower Canada were self-invited guests to a conference in Charlottetown, the purpose of which was to discuss the proposed union of the four British Atlantic colonies. These visitors had traveled great distances to tempt their maritime cousins into an even larger union--a confederation of all the British North American colonies.

They did their work well, for three years later in 1867, Parliament in London, England, passed the British North America Act uniting four of these colonies into the Dominion of Canada.

As I look at this coin, I cannot help but visualize the conferences which it represents, the politicians who hammered out the mold, and the four great peoples who were the pioneers of Canada.

This coin, commonly called the Charlottetown dollar, was minted in 1964 to commemorate the centennial of the Confederation Conferences. However, the coin should more properly be called the Charlottetown-Quebec dollar, as a second conference was held in Quebec City in October, 1864; it was at this conference that the final documents were drafted for submission to the British Government.

The symbol on the reverse is significant in that it entwines the floral emblems of the four great nations that settled the Canadian lands; the fleur-de-lis of France, the rose of England, the thistle of Scotland, and the shamrock of Ireland.

Ironically enough Prince Edward Island rejected membership in the new confederation. Although this province is now called the Cradle of Confederation, it did not join the confederation until 1873. The provinces of Upper Canada (Ontario), Lower Canada (Quebec), New Brunswick and Nova Scotia (which is the Latin name for New Scotland) joined to form the Dominion of Canada in 1867.

My distant cousin must have been well pleased with his boat ride on that long ago day, for he was Sir John Alexander MacDonalld, the first Prime Minister of the infant Dominion of Canada.

\*\*\*\*\*

GENTLE REMINDER:.....

Have you paid your 1993 Membership dues as yet??? We ask you to do so now...to enable us to get our mailing list in order.....

Thank you!

\*\*\*\*\*

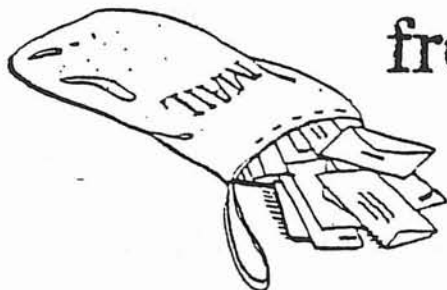

# from the Mailbag

**JÉRÔME H. REMICK**

BOX 9183  
STE-FOY, P.Q., CANADA  
G1V 4B1

17 Jan. 1993

Happy New Year Tom:

Here is an article for a future O.N.A. Journal. Edit it as you wish. I enclose two sizes of photos--actual and reduced by 40%. You may look on this article as a talk I might deliver before a coin club with banknotes to pass around. The O.N.A. Journal reaches many clubs, so my suggestion for a secondary collection for collectors, of one note from each country, will reach many. You have done a very good job in the O.N.A. Journal and Ingersoll Journal in getting in foreign articles to interest collectors in the coins. I know you feel as I do, that some collectors may become bored or disinterested just with current Canadian coins. They need a secondary collection to stimulate them and their senses with attractive and interesting material that is inexpensive. Foreign banknotes, as I outline them in my article, are inexpensive--one from each country, colorful, and fun. Fun. Fun, as there are new countries issuing their own banknotes each year, so the collector has something to look forward to, and to read the newspapers for.

Thank you for typing up the enclosed article.....

Best Wishes

Jerry Remick

\*\*\*\*\*



## Oshawa & District Coin Club

BOX 212, OSHAWA, ONTARIO L1H 7L1

Jan 04 1993

**Editor**

If your Newspaper has a bulletin Board column and/or upcoming events column, we would very much appreciate your addition of the *Oshawa & District Coin Club* meeting schedule as well as the following contact name for more information.

Scheduled dates are:

Jan 10 93 | Feb 14 93 | Mar 14 93 | Apr 18 93 | May 16 93 | Jun 13 93  
Meeting place is the Arts Resource Centre on Queen St. behind City Hall  
For more information phone the Editor Earl MacLean at 728-1352

*Oshawa & District Coin Club*

Earl MacLean

Editor

I N M E M O R I A M

\*\*\*\*\*  
\*\*\*\*\*

TRUDY LAMBERT

Trudy Lambert of St. Catharines died on November 28, 1992. She was a member of the St. Catharines Coin Club for a number of years.

When St. Catharines Coin Club hosted the Ontario Numismatic Association's Convention here, Trudy was active on the Convention Committees.

Trudy was a Life Member of the Ontario Numismatic Association.

From May 1968 to May 1975 she was Secretary of the Ontario Numismatic Association.

Trudy was awarded the prestigious O.N.A. Award of Merit in 1980 for her contribution to Numismatics.

Our sympathy is extended to her family at this time.

\*\*\*\*\*

FRED HURLEY

Fred Hurley of Sarnia died recently after a lengthy illness.

Fred was the immediate Past President of the Sarnia Coin Club, and a collector who was truly interested in the hobby. His collection spanned many years and covered several fields.

The numismatic family has lost one of its own, the Sarnia Coin Club a dedicated worker, the Hurley family a loved one.

To the Hurley family we extend our heartfelt sympathy.

\*\*\*\*\*  
\*\*\*\*\*

A COLLECTION OF ONE BANKNOTE  
FROM EACH OF THE 188 COUNTRIES CURRENTLY ISSUING THEM  
IS VERY INSTRUCTIVE

The table that accompanies this article lists the 187 countries currently issuing their own banknotes and 23 countries that use banknotes of another country as they have none of their own. It also lists, as of October 18, 1992, the number of units of currency for any country needed to purchase one United States dollar, except for a few countries, where values with a marked "M" indicate how much it costs in United States currency to buy one foreign unit. For example, the Table shows that on October 16, 1992, \$1.245 Canadian dollars purchased one dollar U.S., but it took \$1.75 U.S. to purchase one pound of Ireland's currency.

This Table is a useful check-list for those who wish to form a collection of one or more banknotes for each country currently issuing them. This is a most instructive collection, especially for a youngster, as the youngster learns geography, the relative value of each country's monetary unit and something about the country.

Twenty-three countries listed in the Table use the banknotes of another country as they have none of their own, so they can be crossed off the list and need not be collected. This leaves 187 countries listed in the Table that issue their own banknotes. Countries listed in the Table that use banknotes of other countries are: Andorra, Armenia, British Virgin Islands, Georgia, Greenland, Kazakhstan, Kiribati, Kyrgyzstan, Liechtenstein, Marshall Islands, Monaco, Montenegro, Namibia, Nauru, Palau, Panama, San Marino, Tajikistan, Turkmenistan, Turks & Caicos, Tuvalu, Uzbekistan and Vatican City. The seven Russian republics listed in this paragraph are now using the Russian ruble as currency, and will probably eventually have their own currency. Greenland, Liechtenstein, Namibia, and Panama once had their own banknotes.

C.P.A., C.F.P., East Caribbean and Sterling which appear under the country column in the Table are monetary units used by four different groups of countries, each country being listed separately in the Table. So, these four monetary units can be crossed off the Table as they are not separate note issuing countries.

The United States of America should be added to the Table. So after crossing off the 23 above-mentioned countries not having notes of their own and the four monetary units listed in the country column, and adding the United States to the Table, we are left with 188 countries currently issuing their own banknotes.

Eight Caribbean Island countries, all former British Colonies, use banknotes issued by the Eastern Caribbean Central Bank, each country having its own letter after the serial number. Otherwise, the notes are identical. These banknotes are catalogued under East Caribbean States in the "Standard Catalogue of World Paper Money, Volume II" by Albert Pick. The countries with their identifying letter after the serial number are: Antigua (A), Dominica (D), Grenada (G), St. Kitts (K), St. Lucia (L), Montserrat (M), Anguilla (U), and St. Vincent (V). Since the only difference in the notes



**JÉRÔME H. REMICK**  
 BOX 9183  
 STE-FOY, P.Q., CANADA  
 G1V 4B1

.....

A COLLECTION OF BANKNOTES (Cont'd)

issued by each of these eight countries is a letter after the serial number, some collectors of one note from each country may wish to collect one type note issued by the Eastern Caribbean Central Bank rather than the series of eight notes each having a different letter. While the \$1.00 note issued by the Eastern Caribbean Central Bank was replaced by a coin a few years ago, it is still available from some dealers in uncirculated condition for about \$2.50 U.S. The \$5.00 banknote is now the lowest denomination being issued for this area.

Seven African countries, all former French colonies, use the banknotes issued by the Banque Centrale des Etats de l'Afrique de l'Ouest, which is catalogued under West African States in Albert Pick's catalogue cited above. Each country has its own distinctive letter on the obverse side of each note in the bottom left corner and the upper right corner. Except for this identifying letter, the notes are identical. The countries with their distinctive letter in the bottom left and upper right corners on the obverse side are: Ivory Coast (A), Benin (B), Bukina Faso (C), Mali (D), Niger (H), Senegal (K), and Togo (T). Again, some collectors of one note from each country may wish to collect just one type of note issued by the Banque Centrale des Etats de l'Afrique de l'Ouest rather than seven notes, each with a different letter.

My advice is to start by collecting one banknote in uncirculated condition from each country now issuing them. The least expensive dealer for one note in uncirculated condition from each country issuing them is dealer Dwight L. Musser, Box 905, Cacaochee, Florida 33537. Mr. Musser has issued a 3 page price list with one banknote from each country plus a long list of uncirculated banknotes from a number of countries at \$0.50 U.S. each. Collect only uncirculated notes. Uncirculated notes from many countries run between \$0.35 and \$1.75 U.S. If you wish to go further, you can collect one note from each country where the country's name has changed. For example, there is British Honduras which is now known as Belize, and Rhodesia which is now known as Zimbabwe.

There are also some countries which once issued notes, but no longer issue them. Some examples are Greenland, Newfoundland, and St. Pierre & Miquelon, and East Germany.

There are also currency boards which formerly issued notes used in several or more countries, but are now no longer issuing such banknotes. Two examples are West African Currency Board and East African Currency Board.

Once you have one banknote or more from most of the countries currently issuing them, you may wish to start a collection of type notes from one or several countries that interest you or a topical collection with a topic that interests you such as birds, animals, fish, trains, etc. Again try to get notes in uncirculated condition, and, if they are scarce, the best condition you can afford.

Some collectors may wish to collect notes from a number of countries that have a common bond. Examples are notes issued by British Commonwealth countries, former French Colonies, former Portuguese colonies, Arab countries, African countries, etc.

You can store your collection in plastic pages with pockets in them for the notes, or use one paper envelope for the notes of each country. If you use the plastic pages with pockets for a collection of one note for each country, I would suggest that a thin strip of paper be put in the bottom of the pocket with the note for each country giving the name of the country, its monetary unit, and the value of its monetary unit in terms of the U.S. dollar.

.....

A COLLECTION OF BANKNOTES (Cont'd)

"THE STANDARD CATALOG OF WORLD PAPER MONEY, 6th EDITION, VOLUME II, GENERAL ISSUES" by Albert Pick, published in July 1990, is an excellent reference. The 1136 page catalogue is out of print but may still be available from dealers. Its original cost was \$49.00 U.S. plus postage.

A very useful reference showing photos of each denomination of banknote currently circulating in each country is the "MRI BANKERS' GUIDE TO FOREIGN CURRENCY" by Arnoldo Efron. The 232 page catalogue issued quarterly, is available at a special price of \$40.00 U.S. post-paid to numismatists from the publisher Monetary Research International, P.O. Box 3174, Houston, Texas, 77253-3174 (telephone 713 654-1900). A copy of this book should be in each Club library as it is very useful for those visiting foreign countries. The Table shown with this article is taken from the Winter 1992-93 edition on this catalogue.

The International Banknote Society publishes an illustrated quarterly devoted to banknotes of the world and an annual address list of their membership. Their latest address list, contains addresses of over 2160 members from 82 countries, so there is a good possibility for trading and pen pals. Annual dues are \$17.50 U.S., and may be sent to Milan Alusic, P.O. Box 1642, Racine, Wisconsin, 53401. A large number of dealers in foreign notes advertise in this journal now in its 32nd year.

Other dealers, besides Mr. Musser, whose address is listed above, have extensive price lists of foreign notes. Several are: Gary Snover, P.O. Box 9696, San Bernardino, Calif. 92427, USA; William Henderson, P.O. Box 73037, Puyallup, Washington, 98373; and Milt Blackburn, P.O. Box 33888, Station D, Vancouver, B.C., V6J 4L6. Specialized price lists for Banknotes of the Arab World are available from Armen, P.O. Box 15204, Lenexa, Kansas 66285-5204 and William Agal, P.O. Box 8615, Mission Hills, Calif. 91346-8615.

BANQUE CENTRAL DES ETATS DE L'AFRIQUE 500 francs

The letter "T" in the lower left and upper right hand corner indicates for which of the 7 West African States this 500 francs banknote was issued. In the example photographed, the letter "T" indicates the note was issued for use in Togo. Note that the "T" in the upper right hand corner is partly covered by the upper part of the tree and starts about  $\frac{1}{4}$  inch below the "6" of "L. 64".

EASTERN CARIBBEAN CENTRAL BANK \$1.00

The suffix after the serial number indicates for which of the 8 countries using the Eastern Caribbean Central Bank's banknotes issued the note. In the example photographed, the suffix "V" indicates the note was issued for use in St. Vincent.



## MRI BANKERS' GUIDE TO FOREIGN CURRENCY

Official tourist rates of exchange as of October 18, 1992, in foreign units per USD, except those marked "M", which indicates how much it costs in U.S. currency to buy one foreign unit. FOR INFORMATION ONLY.

Afghanistan	Afghani	1,163.00	Georgia	Russian Ruble		Nicaragua	Córdoba Oro	5.40
Albania	Lek	110.00	Germany	D.Mark	1.48	Niger	See C.F.A.	
Algeria	Dinar	21.80	Ghana	Cedi	480.00	Nigeria	Naira	19.50
Andorra	See Spain and France		Gibraltar	At par with Sterling		Northern Ireland	See Sterling	
Angola	New Kwanza	970.00	Greece	Drachma	193.50	Norway	Krone	5.99
Anguilla	See East Caribbean		Greenland	See Denmark		Oman	Rial	3851
Antigua+Barbuda	See East Caribbean		Grenada	See East Caribbean		Pakistan	Rupee	25.15
Argentina	Peso	.99	Guatemala	Quetzal	5.35	Palau	U S Dollar	
Armenia	Tram	N/A	Guernsey	At par with Sterling		Panama	Balboa	1.00
Aruba	Florin	1.79	Guinea Bissau	Peso	5,000.00	Papua New Guinea	Kina	1.04M
Australia	Dollar	.7195M	Guinea Conakry	Franc	312.00	Paraguay	Guarani	1,555.00
Austria	Schilling	10.46	Guyana	Dollar	125.50	Peru	Nuevo Sol	1.53
Azerbaijan	Manat	33.40	Haiti	Gourde	10.00	Philippines	Piso	24.75
Bahamas	Dollar	1.00	Honduras	Lempira	5.80	Poland	Zloty	14,200.00
Bahrain	Dinar	.3770	Hong Kong	Dollar	7.73	Portugal	Escudo	131.00
Bangladesh	Taka	39.00	Hungary	Forint	78.30	Qatar	Riyal	3.60
Barbados	Dollar	1.98	Iceland	Krona	55.50	Romania	Leu	430.00
Belarus	Rubel	33.40	India	Rupee	0352M	Russia	Ruble	334.00
Belgium	Franc	30.54	Indonesia	Rupiah	2,043.00	Rwanda	Franc	139.15
Belize	Dollar	1.98	Iran	Rial	1,440.00	St Helena	At par with Sterling	
Benin	See C.F.A.		Iraq	Dinar	3.00M	St Kitts+Nevis	See East Caribbean	
Bermuda	Dollar	1.00	Ireland	Punt	1.76M	St Lucia	See East Caribbean	
Bhutan Ngultrum	At par with India		Isle of Man	At par with Sterling		St Vincent	See East Caribbean	
Bolivia	Boliviano	4.01	Israel	New Sheqel	2.47	San Manno	See Italy	
Bosnia-Herzegovina	N/A		Italy	Lira	1,308.00	S Tome & Prince	Dobra	240.00
Botswana	Pula	.4710M	Ivory Coast	See C.F.A.		Saudi Arabia	Riyal	3.74
Brazil	Cruzeiro	7450.00	Jamaica	Dollar	21.80	Scotland	See Sterling	
British Virgin Isl	Dollar	1.00	Japan	Yen	119.90	Senegal	See C.F.A.	
Brunei Ringgit	At par with Singapore		Jersey	At par with Sterling		Seychelles	Rupee	4.99
Bulgaria	Lev	23.00	Jordan	Dinar	1.48M	Sierra Leone	Leone	500.00
Burkina Faso	See C.F.A.		Kazakhstan	Russian Ruble		Singapore	Dollar	1.60
Burundi	Franc	205.50	Kenya	Shilling	33.70	Slovenia	Tolar	80.00
Cambodia	Riel	2000.00	Kiribati	See Australia		Solomon Is	Dollar	2.94
Cameroon	See C.F.A.		Korea PDR	Won	2.15	Somalia	Shilin	7,800.00
Canada	Dollar	1.2450	Korea Republic	Won	782.00	South Africa	Rand	2.90
Cape Verde	Escudo	63.10	Kuwait	Dinar	.2938	Spain	Peseta	106.00
Cayman Is.	Dollar	1.20M	Kyrgyzstan	Russian Ruble		Sri Lanka	Rupee	44.20
Central African Rep	See		Laos	Kip	715.00	Sterling	Pound	1.6340M
C.F.A.			Latvia	Rublis	180.00	Sudan	Dinar	10.00
C. F. A.	Franc	252.00	Lebanon	Pound	2,350.00	Surinam	Gulden	1.79
C. F. P.	Franc	91.64	Lesotho Maloti	At par with South Africa		Swaziland	At par with South Africa	
Chad	See C.F.A.		Liberia	Dollar	1.00	Sweden	Krona	5.60
Chile	Peso	375.00	Libya	Dinar	.2740	Switzerland	Franc	1.32
China Peoples Rep	Renminbi Yuan	5.54	Liechtenstein	See Switzerland		Syria	Pound	104.00
Colombia	Peso	670.00	Lithuania	At par with Russian Rubles		Taiwan	NT Dollar	25.20
Comoros	At par with C.F.A.		Luxembourg	Franc At par with Belgium		Tajikistan	Russian Ruble	
Congo Republic	See C.F.A.		Macao	Pataca	7.99	Tanzania	Shilling	325.00
Cook Is Dollar	At par with New Zealand		Macedonia	Denar	510.00	Thailand	Baht	25.20
Costa Rica	Colón	136.00	Madagascar	Franc	1,830.00	Togo	See C.F.A.	
Croatia	Dinar	320.00	Malawi	Kwacha	4.09	Tonga	Pa'anga	1.38
Cuba	Peso	.7575	Malaysia	Ringgit	2.50	Trinidad Tobago	Dollar	4.55
Cyprus	Pound	2.28M	Maldives Is	Rufiyaa	11.52	Tunisia	Dinar	.82
Czech+Slovak Rep	Koruna	27.25	Mali	See C.F.A.		Turkey	Lira	7455.00
Denmark	Krona	5.69	Malta	Lira	3.21M	Turkmenistan	Russian Ruble	
Djibouti	Franc	177.70	Marshall Is	U S Dollar		Turks & Caicos	Dollar	1.00
Dominica	See East Caribbean		Mauritania	Ougiyaa	106.00	Tuvalu	See Australia	
Dominican Rep	Peso	13.00	Mauritius	Rupee	15.25	Uganda	New Shilling	1,182.00
East Caribbean	Dollar	2.69	Mexico	Peso	3,056.00	Ukraine	Karbovanets	250.00
Ecuador	Sucre	2,000.00	Moldova	Leu	334.00	United Arab Emirts	Dirham	3.65
Egypt	Pound	3.31	Monaco	See France		Uruguay	Nuevo Peso	3,350.00
El Salvador	Colón	8.60	Mongolia	Tugrug	100.00	Uzbekistan	Russian Ruble	
England	See Sterling		Montenegro	See Yugoslavia		Vanuatu	Vatu	112.50
Equat Guinea	See C.F.A.		Montserrat	See East Caribbean		Vatican City	See Italy	
Estonia	Kroon	11.84	Morocco	Dirham	7.75	Venezuela	So'fivar	75.90
Ethiopia	Birr	5.00	Mozambique	Metical	2,725.00	Vietnam	Dong	10,880.00
Falkland/Malvinas	At par with Sterling		Myanmar	Kyat	5.88	Western Samoa	Tala	2.45
Faroe Is Krona	At par with Denmark		Namibia	See South Africa		Yemen	Rial	16.50
Fiji Islands	Dollar	.6640M	Nauru	See Australia		Yugoslavia	New dinar	200.00
Finland	Markka	4.71	Nepal	Rupee	46.63	Zaire	Zaire	1,150,000.00
France	Franc	5.04	Netherlands	Gulden	1.66	Zambia	Kwacha	200.00
French Polynesia	See C.F.P.		Neth Antilles	Gulden	1.79	Zimbabwe	Dollar	5.17
Gabon	See C.F.A.		New Caledonia	See C.F.P.				
Gambia	Dalasi	8.30	New Zealand	Dollar	.5420M			



## PERSONALITIES on ANCIENT COINS

# NERO

by William Rodger

Though Nero is celebrated in legend for fiddling while Rome burned in 64 A.D. there is no historical basis for this belief. He was, however, much addicted to entertainment, games and music, and was known for the vast banquets served in his honor. Born the son of Agrippina II in 37 A.D., Nero's real name was Claudius Caesar. When Agrippina later married Claudius I, the Roman Emperor, she coerced him into legally adopting the child, so that he would be in line to succeed to the throne. When Nero reached the age of 17, Agrippina poisoned Claudius and Nero became emperor.

Before Nero reached power it is suspected he gave the orders for the poisoning of Britannicus, son of Claudius, who might otherwise have proved a thorn in his side once Claudius was out of the way. He then proceeded to poison his mother. However, these murders did not rid the world of his supposed enemies.

Roman society was at the height of its grandeur; producing poets, philosophers, surgeons and other distinguished men like grapes upon a vine. Commerce flowed freely into Rome and its products were widely sold. Roman architecture and Roman artists were acclaimed the finest known. But while common society had attained such a high level, the Roman government had experienced a series of misfortunes.

Caesar had been assassinated in 44 B.C.; Caligula met the same fate in 41 A.D. while numerous other officials had been done away with along the line. The public, though far from discontented, held little faith in the men invested with power. An emperor of strong character and appeal was necessary to reverse the picture, but in Nero the Romans received a tyrant who ignored their wishes and needs, spending most of his time guarding against assassination.

The reign of Nero, while prosperous enough during most of his years, lacked all attempt at order and the government ended up as chaotic as his personal life. When he murdered his wife, Octavia, it was almost accepted as a foregone conclusion. But the burning of Rome was another matter. It affected the average citizen and was not to be brushed off lightly. Those who were opposed to Nero claimed he ordered the fire set, out of his distorted imagination, and considering his past record anything was possible. The fact that he appeared rather unconcerned during the entire happenings--or, at least, so people said--gave support to this theory.

Nero himself bellowed that the Christians, that new, mischievous sect of religious fanatics, were responsible. They had been giving Rome all sorts of trouble, going about the streets preaching and denouncing accepted pagan beliefs--the previous emperors had regarded them more or less as nuisances. Nero, who had ignored them the



*Silver Tetradrachm 54-68 A.D. Struck at Antioch.*

.....

PERSONALITIES ON ANCIENT COINS (Cont'd)

the same as he ignored everything else, decided this was the chance to show his public spirit. Thus began the now famous persecution of the Christians in which they were given over to the lions while tens of thousands cheered. Their services of worship were forbidden within Rome, even if held in private.

At first Nero reveled in the persecutions. It was taken in the spirit of the times, which were brutal enough, and was considered great fun. If Christians were thrown in jail to starve, they were thought to have gotten their just reward. If Roman soldiers broke up secret masses and killed the participants, they were regarded as heroic.

But things did not continue to go so well for Nero. The following year, 65 A.D., he imagined himself the target of an assassination plot and quickly, nervously began to execute those he felt might be involved. Even the great poet Seneca and Nero's current wife were killed, but nothing could give him peace. The more he exterminated, the more seemed to rise up against him and revolts became the order of the day. The last three years of his life were tormented, as he saw in every action a plot, and the Roman people who he falsely believed had a high regard of him, turned against him.

Finally, in the midst of a serious revolt in 68 A.D. he committed suicide, at the age of 31. As he lay dying his vanity was such that he murmured, "What an artist the world is losing in me!" After a contest for power he was succeeded by Vespasian in 69.

The legends involving Nero are many, though he lived such a short period of time. The classical authors make frequent reference to his habits and much of what was said was undoubtedly true. A lover of wine, women, poetry, the arts, and all forms of luxury, Nero was slothful, unrealistic, and totally unaware of his role in the world. He used the position of emperor only to further his own reckless whims and supply himself greater opportunity for leisure, gluttony, and sport.

\*\*\*\*\*

Y'S UPNETHERLANDS SILVER 10 GULDEN COIN

It was the first such coin issued by the Netherlands, and is said to have been struck of silver salvaged from about 20 million one gulden pieces which were withdrawn from circulation. This coin was issued in 1970 to commemorate the 25th Anniversary of the March 1945 liberation of the Netherlands from Germany's World War II occupation. This two headed coin bears on the obverse the portrait of

Queen Juliana, and on the reverse, the portrait of Queen Wilhelmina, who was in her 55th year as sovereign. The legend on the reverse reads, "Nederland Herrijst" or "Netherlands Uprises", and is a tribute to the resistance movement in the Netherlands, which played a key role in the ultimate defeat of the German forces. The coin was struck of .720 fine silver at the Utrecht Mint, and bears a lettered edge, "God Zij Met Ons" or "God Be With Us".



\*\*\*\*\*

# SHOW AND BOURSE

- February 27-28 (TOREX SHOW - Primrose Hotel, 111 Carlton St., Downtown  
June 26-27 (Toronto. Info: Ingrid K. Smith, P.O. Box 865,  
October 23-24 (Adelaide St. P.O., Toronto, Ont., M5C 2K1. Phone -  
(416 586 0098.
- March 21 MARYSVILLE MICHIGAN COIN CLUB ANNUAL COIN SHOW - American  
Legion Hall, 229E Huron Blvd. Marysville, Michigan.  
Bourse sold out. Hours 10 a.m. - 5 p.m. Free Admission.  
Info: Charles Springborn (313) 329 4082.
- March 27 CAMBRIDGE COIN CLUB 2nd ANNUAL COIN SHOW - Lions Club  
Community Hall, 50-52 Ainslie St., N., Cambridge-Galt,  
Ont., Free Admission. Info: Bill Wellsman (519)621 7716.
- April 3 (HAMILTON COIN CLUB SEMI-ANNUAL COIN SHOW - Royal Can-  
October 2 (adian Legion, Branch 58, 1180 Barton St. E., upstairs,  
(Hamilton, Ont. Hours 9 a.m.- 4 p.m. Free Admission.
- April 4 KENT COUNTY (CHATHAM) ANNUAL COIN SHOW - Wheels Motor Inn,  
Cnr Highway 2 & Keil Dr. Free Admission & Parking,  
Displays invited. Hours 10 a.m.- 4 p.m.
- April 16-18 O.N.A. 31st ANNUAL CONVENTION & SHOW - College Inn,  
Guelph. Info: O.N.A., P.O. Box 33, Waterloo, Ontario,  
N2J 3Z6.
- May 2 (WINDSOR COIN CLUB SPRING SHOW - Knights of Columbus Hall,  
(1140 Goyeau St. Hours 9:30- 5:00 p.m.
- November 14 (FALL SHOW - Date & Location to be confirmed in later issue.  
(Info: Ron Binder (519) 254 6855, or 2279 Hall Ave.  
(Windsor, N8W 2L8.
- May 15 BURLINGTON INTERNATIONAL COIN SHOW - Mainway Recreational  
Centre, Laurie Branch Auditorium, Exit North off Queen  
Elizabeth Way, at Walker Line. Free Admission. Hours  
9 a.m.- 4 p.m. Info: N. Kanerva (416) 335 9444.
- May 27 PETERBOROUGH COIN CLUB SHOW AND BOURSE - Portage Place  
Mall, Chemong Road, Peterborough. Free Admission. Info:  
Colin Caldwell (705) 742 0114.
- June 13 BRANTFORD NUMISMATIC SOCIETY ANNUAL SHOW & BOURSE - Wood-  
man Community Centre, 491 Grey Street, Brantford, Free  
Admission. Hours 8 a.m.- 5 p.m. Info: B.N.S., Box 351,  
Brantford, Ontario, N3T 5N3.
- July 20-25 C.N.A. ANNUAL CONVENTION - Keddy's Brunswick Hotel,  
Moncton, N.B. Info: Moncton Coin Club, P.O. Box 54,  
Moncton, N.B., E1C 8R9.
- September 11 HURONIA NUMISMATIC ASSOCIATION COIN, STAMP, ANTIQUE  
SHOW - Bayfield Mall, Bayfield St. N., Barrie, Ontario  
Info: P.O. Box 243, Barrie, Ontario, L4M 4T2.
- September 12 WOODSTOCK COIN CLUB 4th ANNUAL COIN SHOW - U.A.W. Hall,  
Beale St., Woodstock. Info: Woodstock Coin Club  
549 Grace Street, Woodstock, Ont., N4S 4N7. Hrs. 9 a.m.-  
4 p.m.
- .....

SHOW & BOURSE (Cont'd)

- September 18 ST. CATHARINES COIN CLUB ANNUAL COIN SHOW - Russell Ave. Community Centre, 108 Russell Ave., St. Catharines. Info: St. Catharines Coin Club, P.O. Box 1492, St. Catharines, Ontario, L2R 7J9.
- October 31 STRATFORD COIN CLUB ANNUAL COIN SHOW - Stratford Kiwanis Centre, Lakeside Drive, Stratford. Info: Stratford Coin Club, Box 21031, Stratford, Ontario, N5A 7V4.
- November 7 TILLSONBURG COIN CLUB ANNUAL COIN & HOBBY SHOW - Mount Elgin Community Centre, 5 miles south of 401 and 5 miles north of Tillsonburg on Highway 19 - Exit south off 401 on Highway 19, Ingersoll-Tillsonburg exit. Info: W. Baxter 46 Queen Street, Tillsonburg, Ontario, N4G 3G9.
- Second Sunday OTTAWA COIN, STAMP, DEALERS ASSOCIATION SHOW - Nepean Each Month Sportsplex, Woodsroffe Ave., 10 a.m.- 4 p.m. Info: Allan Davis, P.O. Box 307, Carp, Ontario, DOA 1L0.

\*\*\*\*\*  
 TO AVOID A SITUATION WHERE TWO OR MORE COIN SHOWS ARE SCHEDULED ON THE SAME DAY, IT IS IMPORTANT THAT YOU GET YOUR 1993 AND 1994 SHOW DATES TO THE C N.A. EDITOR AS SOON AS POSSIBLE. LET'S NOT HAVE ANOTHER CANCELLATION BECAUSE OF A CONFLICT OF DATES!!!  
 \*\*\*\*\*

DEADLINE FOR MARCH-APRIL ISSUE.....MARCH 15th

\*\*\*\*\*  
RECEIVED TOO LATE TO BE INCLUDED IN REGULAR LISTING.....

- November 27 WATERLOO COIN SOCIETY COIN SHOW - The Rink In The Park, Seagram Drive, Waterloo. Hours 10 a.m.- 5 p.m. Free Admission and Free Parking. Info: Don Robb, Box 724, Waterloo, Ont., N2J 4C2 (519) 888 9655.

\*\*\*\*\*

DID YOU KNOW????

That the U.S. Lincoln cent was conceived to commemorate the 100th Anniversary of Abraham Lincoln's birth, and today it is the longevity king of all U.S. coins.



It was in 1977 that it surpassed the coronet type gold quarter eagle, which at that time was the longevity coin, and was minted for 68 years from 1840-1907.

All of us recognize the Lincoln cent, whether the Wheat or the Memorial variety, but few realize it has been minted by the billions for a total of 84 years. Will the Lincoln cent reach the age of 100? Only time will tell.

T. Masters  
 \*\*\*\*\*

ONTARIO NUMISMATIC ASSOCIATION  
 31st ANNUAL CONVENTION AND COIN SHOW  
 COLLEGE INN, GUELPH ONTARIO  
 APRIL 16-18

\*\*\*\*\*

NAME \_\_\_\_\_

ADDRESS \_\_\_\_\_ TEL. # \_\_\_\_\_

CITY \_\_\_\_\_ PROV. \_\_\_\_\_ CODE \_\_\_\_\_

\*\*\*\*\*

QUANTITY	ITEM	COST PER ITEM OR PERSON	TOTAL
----------	------	----------------------------	-------

_____	CONVENTION PRE-REGISTRATION KIT Includes: Admission to Show, O.N.A. Draw Ticket, Full Bar Reception, Gold Plate Convention Medal, Con- vention Woods, Use of Hospitality Room, Penny Draw Tickets and much more.	\$ 25.00	_____
-------	---	----------	-------

_____	PRE-REGISTRATION KIT Same as above except no Gold Plate Convention medal	\$ 15.00	_____
-------	--	----------	-------

*Guarantee! If you are not completely satisfied  
 with your Convention Kit, return  
 Kit, receive your money back and  
 Unlimited Free Admission to the Show!*

Friday, April 16th 9:00 p.m.  
 Full Bar Reception, Included in  
 Pre-registration Kit.

Unregistered Guests (Refreshments)	\$ 7.50	_____
------------------------------------	---------	-------

Saturday, April 17th, 9:30 a.m.	Bus & Conducted Tour- Church of Our Lady, featured on Medallion Max. 25 Reservations only.	\$ 4.00	_____
---------------------------------	--	---------	-------

April 17th, 6:30 p.m. O.N.A. Banquet and Guest Speaker <i>Includes Post Banquet Reception</i> Rev. Roger McCombe is one of the finest speakers and we know that everyone attending will remember the evening for years to come.	\$ 25.00	_____
---	----------	-------

Sunday, April 18th, 8:30 a.m.	Club Delegates Breakfast.	\$ 10.00	_____
-------------------------------	---------------------------	----------	-------

Convention Medals .999 Silver	\$ 35.00	_____
----------------------------------	----------	-------

Antique Bronze	\$ 7.50	_____
----------------	---------	-------

Gold Plate available only in  
 Pre-registration Kits.

	TOTAL	=====
--	-------	-------

*Please make cheque or Money order Payable to O.N.A. Convention 93  
 and return with form to: P.O. Box 33, WATERLOO, Ontario. N2J 3Z6*

Medals, Banquet and Delegate Breakfast **INCLUDE** taxes & gatuity.

# O.N.A. '93

## COINS & COLLECTIBLES SHOW

Ontario Numismatic Association  
31st Annual Convention & show

**APRIL 17, 18, 1993**

### **College Inn**

Stone Road & Gordon Street  
Guelph, Ontario  
519-836-1240  
1-800-563-9240

For Information Contact:  
Ontario Numismatic Association  
Box 33  
Waterloo, Ontario  
N2J 3Z6

**Doors Open**  
**SATURDAY 10:00 A.M. - 6:00 P.M.**  
**SUNDAY 10:00 - 5:00 P.M.**

Dealers  
Displays  
Door Draws  
Auction  
Cards  
and Much More

**PUBLIC WELCOME**

Admission \$2.00  
Free Parking

Children & Seniors Free  
When Accompanied by a Parent



# THE ONTARIO NUMISMATIST

OFFICIAL PUBLICATION OF THE ONTARIO NUMISMATIC ASSOCIATION

ISSN 0048-1815

VOLUME 32 MARCH-APRIL CONVENTION ISSUE PG. 17-93

1991-1993

## O.N.A. OFFICERS

### Immediate Past President

K. Wilmot

### President

G. Oblinski

### First Vice President

R. Zelk

### Second Vice President

Vacant

### Secretary

E. Dezo

### Treasurer & Membership

B. H. Raszmann

Box 33, Waterloo, N2J 3Z6

### Directors:

- Area: 1a T. Kostaluk  
1b S. Hodge  
2 T. Masters  
3 R. Voaden  
4 R. Fletcher  
5 K. Wilmot  
6 E. Workman  
7 H. Farrow  
8 B. Watt  
9 B. Uman  
10 R. Albert

### Head Judge

E. Workman

R. R. #2 Cannington, Ont.

LOE 1EO

### Speakers Circuit & Convention Co-Ordinator

T. Kennedy

### Audio-Visual Service

K. Koch

219 Southwood Drive

Kitchener, Ont. N2E 2B2

### Editor-Librarian

T. Masters

823 Van Street

London, Ont. N5Z 1M8



ARTIST'S

CONCEPTION

.....ACTUAL SIZE

The ONTARIO NUMISMATIST is published by the Ontario Numismatic Association. The publication can be obtained with membership in one of the following categories: Regular Membership \$10.00 annually; Husband & Wife (one journal) \$12.00 annually; Junior (up to 18) \$3.00 annually. Life Memberships available for \$100.00 after 3 years of regular membership. Club Membership \$15.00. Remittances payable to the Ontario Numismatic Assoc. P.O. Box 33, Waterloo, Ont. N2J 3Z6



It's O.N.A. Convention time again!!!! This will be your last opportunity to Pre Register for the various programs offered, so I implore you to look elsewhere in this issue for that form and get it in today. Those who attended last year's Convention (at the same site) must agree with me that it was a very good event. Many of those who were on last year's Convention committee are again serving on the 1993 Show, and with last year's experience, this year's plans are for an even better Show. Bourse has been sold out for months, a tour has been offered, meetings expanded, and one of the Best Banquet Speakers in Ontario, Roger McCombe, will wind up a great Saturday night.

Who will be the winner of the Ontario Numismatic Association's "Award of Merit", the Best Bulletin Award, the Display Awards??? To find the answer to these questions attend the Convention, or you may have to wait until our next issue to find those answers.

Who will win our Dream Vacation Draw??? Be on hand at 4:30 p.m. on Sunday for that important draw to find out first hand. While on that subject let me remind you that all received a book (s) of those draw tickets. It's now time to get them back to the address found on the cover of those books. If you haven't sold those tickets, do so now. Remember...if you don't have a ticket you can't win, and the \$1250. Vacation or the \$1000. cash is a very good return for just \$2.00 Your odds are a great deal better than any lottery ticket you might buy each week. I know it's the hope of the O.N.A. Executive that every Club has a Delegate at the Sunday 8:30 a.m. Delegates Breakfast. This year's format will give the Delegates the opportunity to express their views..pro and con...about the hobby and Clubs in general. It's hoped that all Clubs take notice and prepare their Delegate with a written resume. Your input may help some Clubs who are experiencing difficulty in some area. That \$10.00 cost may be one of the best investments your Club makes this year.

I believe this year's Convention will be one of the best ever, and I have attended many. So let's see you out for your assessment too.

Our Show and Bourse column is printed in each issue, and it serves two purposes. First it lets you know the dates and locations of Coin Shows you plan to attend. We print these well in advance (if we get the notice) so you can work them into your schedule. Second with dates known it is hoped that Clubs would not schedule their Shows on the same date as a neighboring Club's date. Last year there was one cancellation because three Shows were scheduled for the same date. It's not the O.N.A.'s policy to tell Clubs when they can have their Show. That's their business, but I would hope that Clubs would take particular notice of all scheduled show dates before they settle on one for themselves. I know there are circumstances where facilities are only available on certain dates, but it's not good planning or policy to have two shows in the same area on the same date. Dealers who purchase bourse tables can't attend both shows, and much of their business depends on these events. Then the collector is shortchanged if he can only attend one show, and finally the Club itself because they have to share dealers and collectors. It's a case of everyone is the loser. Those who have scheduled dual dates I hope they are far enough apart that their show doesn't suffer.

See you at the O.N.A. Guelph Convention April 17-18. Come forward with your comments on all the subjects I have written about.

.....T. Masters.....

# O.N.A. '93

## COINS & COLLECTIBLES SHOW

Ontario Numismatic Association  
31st Annual Convention & show

**APRIL 17, 18, 1993**

### College Inn

Stone Road & Gordon Street  
Guelph, Ontario  
519-836-1240  
1-800-563-9240

For Information Contact:  
Ontario Numismatic Association  
Box 33  
Waterloo, Ontario  
N2J 3Z6

**Doors Open**  
**SATURDAY 10:00 A.M. - 6:00 P.M.**  
**SUNDAY 10:00 - 5:00 P.M.**

Dealers  
Displays  
Door Draws  
Auction  
Cards  
and Much More

**PUBLIC WELCOME**

Admission \$2.00  
Free Parking

Children & Seniors Free  
When Accompanied by a Parent

# 1993 O.N.A. CONVENTION PROGRAM

## Friday, April 16:

- 6:00 PM Security begins
- 6:00 PM - 9:00 PM Registration Table open.
- 6:00 PM - 9:00 PM Bourse Room open to Dealers and Exhibits set up.
- 9:00 PM Full Bar Reception: Free admission to Dealers, Pre-registered Guests and Committee. Nominal charge of \$7.50 to Unregistered Guests. Room 203

## Saturday, April 17:

- 8:00 AM Bourse Room open to Dealers and Exhibits set up.
- 8:00 AM - 6:00 PM Registration Table open
- 8:30 AM Canadian Numismatic Association Executive Meeting Boardroom 103
- 9:30 AM Official Opening and Draw for \$50.00 in Bourse Vouchers.
- 9:30 AM Tour of "The Church Of Our Lady" and Historical Sites. By Ticket only. \$4.00 Bourse Room open to Public.
- 10:00 AM - 4:00 PM Hospitality Suite open. Room 203
- 1:00 PM Canadian Tire Coupon Collectors Club. Pinetree C.
- 1:00 PM Canadian Association of Token Collectors Boardroom 103
- 2:30 PM Charles Moore Auction Pinetree C.
- 3:00 PM Canadian Association of Wooden Money Collectors Boardroom 103
- 5:00 PM Penny Draws.
- 6:00 PM Bourse Room closes.
- 6:30 PM Pre-Banquet Reception: Cash Bar
- 7:00 PM Banquet Speaker: Rev. Roger McCombe. Speaker Extraordinary!! A Treat for all. MC Don Robb. Dining Room
- All Banquet attendees will be invited to a Reception after the Banquet. Hospitality Suite Room 203

## Sunday, April 18:

- 8:30 AM O.N.A. Club Delegate Breakfast Meeting M.C. John Regitko. Dining Room
- 9:00 AM Bourse Room open to Dealers
- 10:00 AM Bourse Room open to Public
- 10:00 AM - 4:00 PM Hospitality Suite open. Room 203
- 11:00 AM O.N.A. General Meeting Pinetree C.
- 1:00 PM Spouse Programme. Many interesting topics and displays. Denna Benn Hospitality Suite Room 203, Refreshments
- 4:00 PM Penny Draws
- 4:30 PM O.N.A. Draw: "DREAM VACATION"
- 5:00 PM Bourse Room Closes
- 5:30 PM Security Ends

1993 O.N.A. CONVENTION ENDS  
"AU REVOIR"

## BANQUET SPEAKER

REV. ROGER McCOMBE



How many have ever heard this person speak at various functions and on most any subject???

If you have heard him you already know what an outstanding speaker we have for this year's Banquet.

For those who have never heard him, you are in for a treat.

I've heard Roger on numerous occasions and when given the opportunity, jump at the chance to hear him again.

Banquet space is limited, so don't miss out on this event. After you have heard Roger, I'm sure you will agree with me, "His speech was worth the price of the Banquet".

What are some of Roger's credits??- Resides in Ingersoll and is an Anglican Priest - Padre for Ingersoll Police - Teacher at Ingersoll High School - Kiwanian - Editor of the Huron Church News - and the list goes on.

We are very fortunate to be able to obtain this very, very busy person. You will be the loser if you miss this event.

\*\*\*\*\*

## MEDAL REPORT

The medal shown on the cover of this issue is an artist's version, and the final striking may slightly vary in design. The "Church of Our Lady" is the main feature of this year's medal. This Roman Catholic Church is the most outstanding building in Guelph, and at present is undergoing extensive renovations. This year's medal promises to be a very prized and cherished item, and with a very limited number struck, could be hard to come by.



.999 Silver will be limited to 35, Antique Bronze to 100, and the Gold Plate to 60. This Gold Plate medal will be included to the first 60 people who pre-register, and reports are that pre registration is going well. After these medals are sold out there will be no further strikings. So..a word to the wise...ORDER YOURS TODAY!!!

\*\*\*\*\*

## DELEGATES BREAKFAST MEETING

Sunday, April 18

8:30 a. m.

Don't let the time scare you...this year's Delegate meeting is in the laps of the Delegates. There will be no speaker at this meeting.

Clubs are urged to prepare their Delegates to the many positive things that make your Club and meetings attractive. We believe that all Delegates should come prepared with a written resume. Many have complained that the Delegates never got a chance to make their Club's views known. This year's format gives you that opportunity to voice all your concerns about what is necessary to improve the hobby.

Plan to attend this event. Send in your reservations today.

\*\*\*\*\*

TOURS

**In Flanders Fields\***

By JOHN McCRAE (1872-1918)

IN Flanders fields the poppies blow  
Between the crosses, row on row,  
That mark our place; and in the sky  
The larks, still bravely singing, fly  
Scarce heard amid the guns below.

We are the Dead. Short days ago  
We lived, felt dawn, saw sunset glow,  
Loved and were loved, and now we lie,  
In Flanders Fields.

Take up our quarrel with the foe:  
To you from failing hands we throw  
The torch; be yours to hold it high.  
If ye break faith with us who die  
We shall not sleep, though poppies grow  
In Flanders Fields.

Here is the opportunity to tour the most outstanding edifice in Guelph. The Church of Our Lady is situated on a hill, and is visible for many miles before reaching the City of Guelph. This tour is limited to 25 so act fast or be disappointed. This two-hour tour cost is a very reasonable \$4.00.

After the tour you might want to stop at the John McCrea Tea Room for afternoon tea. John McCrea was a native of Guelph who wrote the poem, "In Flanders Fields".

This Tea Room stop is on your own and not included on the Registration Form.

\*\*\*\*\*

# ASSOCIATION NEWS

## MEMBERSHIP

The applications for membership which appeared in the January-February issue of the Ontario Numismatist have now been accepted.

The following application has been received. If no written objection to this application is received, acceptance will appear in the next issue of the Ontario Numismatist.

1351                      Gordon Tarzwell                      Fergus, Ontario

\*\*\*\*\*

SHOW & BOURSE (Cont'd)

Received too late to be included in regular listing:

September 19      London Numismatic Society Show  
                         Ramada Inn, Wellington Road at 401  
                         Info: L.N.S. 543 Kininvie Drive  
                         London, Ontario, N6G 1P1

\*\*\*\*\*

DID YOU KNOW???????????

That the only way to acquire the GOLD PLATED CONVENTION MEDAL is through the PRE REGISTRATION KIT....limited to 60. Don't be disappointed...PRE REGISTER NOW!!!!

\*\*\*\*\*

Dear Club Rep,

The fantastic success of the 1992 Canadian 25¢ "Canada 125" program drove home the point that a lot of Canadians that aren't coin collectors collected coins!

**Numismatics** (the study and collecting of coins, medals and paper money) used to be called the Hobby of Kings. We feel it is the King of Hobbies! What was once an expensive past-time for wealthy folk, collecting in the 1990's has become an affordable hobby for people from all economic backgrounds. Let me list a few of the current areas of collecting that appeal to the frugal, but inquisitive mind.

**Canadian Tire coupon collecting!** Mentioned first because it is my favourite. Issued since 1958, there are over 200 different coupons to collect. Free with purchases from Canada's favourite retailer, your collection will grow quickly. Many collectors in the Guelph area to trade with. Watch for the 35th Birthday Bash.

**Wooden nickels.** "Don't take any wooden nickels"?? **NOT!** Take all you can get of this rapidly growing facet of numismatics. There are thousands of different woods to collect and trade. Many collectors issue their own personal "wooden business cards", an inexpensive and novel greeting card.

**Souvenir trade tokens.** Issued by municipalities, fraternal orders, hospitals and charities (K-W Oktoberfest dollars are one local example), they often carry a time-limited, redeemable value. Some people collect them "topically", e.g. portraying animals, trains, famous persons or architecture.

**Classical and Medieval Coinage.** Surprisingly, "old" coins are not all valuable. Prices are based on scarcity, not age, and wonderful collections of ancient Roman coins can be formed within a modest budget.

**Foreign Coins.** One of the most affordable, as many countries issue coins that have very low values relative to the Canadian dollar. An excellent way to brush up on geography and history, as you research the latest addition to your collection.

Regardless of your age, race, physical abilities or gender, "numismatics" has a spot for you. A great family activity, where each member can have their own area of interest. A great way of meeting interesting people!

If someone in your organization might be interested in learning more about this hobby, please make them aware of our upcoming coin show at the College Inn, April 17 and 18. Better yet, bring them with you!

**FREE APPRAISALS AND IDENTIFICATION.** If you have coins and either don't know their value or where they are from, contact us for this free service. Knowing what you have can be important, should you ever wish to sell them or for insurance or estate purposes. You may even become a more interested collector! (Confidentiality is, of course, assured.)

For more information about our coin show, appraisals or any aspect of coin collecting, please feel free to contact me by phone or by writing.

Mike Hollingshead - Box 1000, Arkell, Ontario, N0B 1C0.  
Telephone 823-2646, 822-2910 FAX 837-2341

# SHOW AND BOURSE

- April 16-18 O.N.A. 13th ANNUAL CONVENTION & SHOW - College Inn, Guelph. Info: O.N.A., P.O. Box 33, Waterloo, Ontario. N2J 3Z6.
- May 1 WOODVILLE COIN CLUB ANNUAL SHOW - Royal Canadian Legion Hall, 517 Mara Road, Beaverton, Ontario. 10 a.m.- 5 p.m. Free Admission. Info: Elmer Workman, R.R. #2, Cannington, Ontario, LOE 1E0. Tel. (705)432 2124.
- May 1 PEMBROKE CENTENNIAL COIN CLUB ANNUAL SHOW - 10 a.m.- 4 p.m. West End Mall, Pembroke. Free Admission. Info: Ron Rozeboom, 507 Nelson St., Pembroke, Ontario, K8A 3P2. Tel. (613)732 9878.
- May 2 (WINDSOR COIN CLUB SPRING SHOW - Knights of Columbus Hall, 1140 Goyeau St. Hours 9:30- 5:00 p.m.
- November 14 (FALL SHOW - Date & Location to be confirmed in later issue. (Info: Ron Binder (519)254 6855, or 2279 Hall Ave. (Windsor, N8W 2L8.
- May 15 BURLINGTON INTERNATIONAL COIN SHOW - Mainway Recreational Centre, Laurie Branch Auditorium. Exit North off Queen Elizabeth Way, at Walker Line. Free Admission. Hours 9 a.m.- 4 p.m. Info: N. Kanerva (416)335 9444.
- May 15 OSHAWA & DISTRICT COIN CLUB SHOW - Pickering Town Centre, Pickering. Info: Earl or Sharon MacLean (416)728 1352.
- June 13 BRANTFORD NUMISMATIC SOCIETY ANNUAL SHOW & BOURSE - Woodman Community Centre, 491 Grey Street, Brantford. Free Admission. Hours 8 a.m.- 5 p.m. Info: B.N.S., Box 351, Brantford, Ontario, N3T 5N3.
- June 26-27 (TOREX SHOW - Primrose Hotel, 111 Carlton St., Downtown Toronto. Info: Ingrid K. Smith, P.O. Box 865, Adelaide St. P.O. Toronto, Ont., M5C 2K1. Tel. (416)586 0098.
- October 23-24
- July 20-25 C.N.A. ANNUAL CONVENTION - Keddy's Brunswick Hotel, Moncton, N.B. Info: Moncton Coin Club, P.O. Box 54, Moncton, N.B., E1C 8R9.
- September 11 (HURONIA NUMISMATIC ASSOCIATION COIN, STAMP, ANTIQUE SHOW - February 5/94 (Bayfield Mall, Bayfield St. N., Barrie, Ontario. Info: (P.O. Box 243, Barrie, Ontario, L4M 4T2.
- September 12 WOODSTOCK COIN CLUB 4th ANNUAL COIN SHOW - U.A.W. Hall, Beale St., Woodstock. Info: Woodstock Coin Club, 549 Grace St., Woodstock, Ont., N4S 4N7. Hrs. 9a.m.-4 p.m.
- September 18 ST. CATHARINES COIN CLUB ANNUAL COIN SHOW - Russell Ave. Community Centre, 108 Russell Ave., St. Catharines. Info: St. Catharines Coin Club, P.O. Box 1492, St. Catharines, Ontario, L2R 7J9.
- October 2 HAMILTON COIN CLUB SEMI-ANNUAL COIN SHOW - Royal Canadian Legion, Branch 58, 1180 Barton St. E., upstairs, Hamilton, Ont. Hours 9 a.m.- 4 p.m. Free Admission.
- October 2 NORTH YORK COIN CLUB ANNUAL SHOW - 10 a.m.- 5 p.m. Edithvale Community Centre, 7 Edithvale Drive, North York. Free Admission. Info: North York Coin Club, P.O. Box 58508, Crnr Plaza P.O. 197 Sheppard Ave. E., North York, Ontario M2N 6R7.

.....

SHOW & BOURSE (Cont'd)

- October 31      STRATFORD COIN CLUB ANNUAL COIN SHOW - Stratford Kiwanis Centre, Lakeside Drive, Stratford. Info: Stratford Coin Club, Box 21031, Stratford, Ontario, N5A 7V4.
- November 7      TILLSONBURG COIN CLUB ANNUAL COIN & HOBBY SHOW - Mount Elgin Community Centre, 5 miles south of 401 and 5 miles north of Tillsonburg on Highway 19 - Exit south off 401 on Highway 19, Ingersoll-Tillsonburg exit. Info: W. Baxter, 46 Queen Street, Tillsonburg, Ontario, N4G 3G9.
- November 27      WATERLOO COIN SOCIETY COIN SHOW - The Rink in the Park, Seagram Drive, Waterloo. Hours 10 a.m.- 5 p.m. Free Admission and Free Parking. Info: Don Robb, Box 724 Waterloo, Ont., N2J 4C2 (519) 888 9655.
- Second Sunday      OTTAWA COIN, STAMP, DEALERS ASSOCIATION SHOW - Nepean  
Each Month      Sportsplex, Woodsroffe Ave., 10 a.m.- 4 p.m. Info: Allan Davis, P.O. Box 307, Carp, Ontario, DOA 1L0.

\*\*\*\*\*

In the January-February issue we listed the Peterborough Coin Club's Show as May 27th, when in fact it should have been March 27th. We apologize for this error and any inconvenience it caused.

\*\*\*\*\*

TO AVOID A SITUATION WHERE TWO OR MORE COIN SHOWS ARE SCHEDULED ON THE SAME DAY, IT IS IMPORTANT THAT YOU GET YOUR 1993 AND 1994 SHOW DATES TO THE O.N.A. EDITOR AS SOON AS POSSIBLE. LET'S NOT HAVE ANOTHER CANCELLATION BECAUSE OF A CONFLICT OF DATES!!!!!!

\*\*\*\*\*

Special Note to Bret Evans of the CCN  
& Tom Masters of the ONA

After all my letters about selecting the same date as another show, here I am informing you that the **Oshawa & District Coin Club** show has been scheduled for **May 15 1993** the same date as the **Burlington Show**. I really hope that the two shows are far enough apart as not to effect each other, and I also hope there is enough dealers to go around.

I strongly disagreed with the date of May 15 1993 for the Oshawa Show, but the executive and the Pickering Town Centre made the decision and as a club member & club executive member I must also follow the majority vote.

To both Bret Evans & Tom Masters I hope that we never do this again, and I will start planning the 1994 show now for the Oshawa Club to try and stay away from other known dates. I request that neither of you print this note in whole or in part in your papers or journals.

Yours Truly

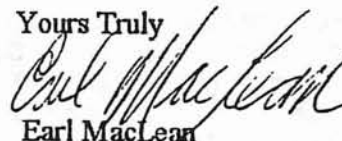

Earl MacLean

Editor

Oshawa &amp; District Coin Club



# Oshawa & District Coin Club

BOX 212, OSHAWA, ONTARIO L1H 7L1

Editor

Feb 16 1993

The *Oshawa & District Coin Club* will be having a large Numismatic show in the *Pickering Town Centre* on May 15 1993. This show will be called *Coin A Rama 93* and will feature **Coins , Tokens , and Paper Money** for **SHOW & SALE**. If further information is required, please contact Earl or Sharon MacLean at 728-1352.

Could you please add this to your bulletin board or upcoming events columns. Thank you in advance.

Yours Truly

Earl MacLean

Editor

Oshawa & District Coin Club



# NORTH YORK COIN CLUB

FOUNDED 1960

MONTHLY MEETINGS 4TH TUESDAY 8 P.M. AT  
Edithvale Community Centre, 7 Edithvale Drive, North York

MAIL ADDRESS- NORTH YORK COIN CLUB, P.O. BOX 58508 Corner Plaza P.O.  
197 Sheppard Avenue East, North York, Ontario, M2N 6R7

## Scarborough Coin Club

---

**Mailing Address:**

Scarborough Coin Club  
P.O. Box 465  
West Hill, Ontario  
Canada M1C 2P0

**Club Meetings:**

Cedarbrook Community Centre  
91 Eastpark Blvd.  
Scarborough, Ontario  
1st Wed of Month at 7:30 p.m.

The Scarborough Coin Club will meet at Heron Park Community Centre, 4285 Lawrence Ave. E., Scarborough for our May, June, September, October and November 1993 meeting. Since Cedarbrook Community Centre is being renovated, we will meet at our new location, 1st Wednesday of the month at 8:00 p.m.



# Oshawa & District Coin Club

BOX 212, OSHAWA, ONTARIO L1H 7L1

Jan. 18 1993

The Royal Canadian Mint  
Mint Director

Subject: 100th Anniversary Olympic COIN Program

Some of our membership has received your flyer regarding your new Olympic COIN program and are concerned with your method of advertising. Some of the members stated that this could be classified as false advertising, I'm not sure if this would be classified as false advertising or not but we do feel that you are leading on the public again when it comes to this program.

As you are well aware the past Olympic coin program was a lot of problems to collectors who wished to redeem them as cash. The Royal Canadian Mint (RCM) stated back when issued that the value on the Coins could be redeemed for cash if the owner wanted. But this was tested in the past few years, the RCM stated that this wasn't the case that the owners were stuck with the coins for only the silver value that was less than the stamped denomination. Only recently has the RCM allowed owners of these past Olympic coins the means of redeeming them by allowing owners to use them as cash when purchasing RCM products.

All your advertising has stated that this is a "Rare opportunity to own Canadian Olympic Coins" From what we can see from the add, the only COIN is the GOLD. The silver ITEMS don't seem to have any denomination either in your ad's or by the pictures. If this is the case, how could you call these silver ITEMS, Coins. Our club feels that the best you could call these would be Olympic MEDALS celebrating the 100th anniversary. The term COIN hopefully in CANADA means Canadian coin currency that can be used to purchase items.

If the RCM is planning on adding a denomination to the ITEMS, will they take the responsibility of allowing the owners to use them as cash if the bottom falls out of the silver & gold markets some time in the future, or will they say that they have to use them to purchase RCM products as mentioned above.

We feel if the Royal Canadian Mint is planning on continuing to market these special collector issues of what they call COINS then they better make sure the people that purchase them can use them as cash if they want too. Otherwise call them what they really are, MEDALS.

Editor

*Oshawa & District Coin Club*

Earl MacLean

C.C. Ontario Numismatic Association  
Canadian Numismatic Association  
Canadian Coin News

WORLD WAR I VETERAN WALTER LOUDON ISSUES WOOD TO  
MARK THE 75th ANNIVERSARY OF THE BATTLE OF VIMY RIDGE



World War I veteran, Walter Loudon, O.N.A.'s eldest member at 94 years of age this January 30, 1993, issued a wood this Spring to mark the Battle of Vimy Ridge, which took place in France on Easter Monday, at 8:30 a.m. April 9, 1917. By noon, after some 3,000 Canadians had been killed and 7,000 wounded, the Ridge was taken. Some 30,000 Canadian Soldiers fought at Vimy, and for the first time under their own Canadian commander. The battle is hailed by some as a landmark in Canadian unity and a testimony to the resourcefulness and integrity of Canadian.



Jerry Remick  
P.O. Box 9183  
Ste. Foy, Quebec  
G1V 4B1

During the Battle of Vimy Ridge, Walter got part of his right ear shot off. If the bullet had been a mm closer to his head, he would have been killed.

Walter, a very friendly fellow and an enthusiastic person about life in general, has attended almost every C.N.A. Convention during the past 12 years, including the 1992 C.N.A. Convention held in Montreal.

While Walter was unable to attend the 1992 O.N.A. Convention in Guelph, he sent in his registration fee for the kit to help out.

Walter was unable to attend the 82nd reunion held in April 1992 of the 103 Calgary Rifles, 10th Canadians and the Calgary Highlanders, his old regiment, so they asked him for a testimonial to be read out at the banquet. Walter's message to his regiment is printed below, and was taken from the regiment's newsletter. Walter also sent a good supply of the golden colored woods he had made to mark the battle of Vimy Ridge so they could be given to each man in uniform at the reunion.

The emblem of his regiment is shown on the obverse, "10th CANADIANS CALGARY / LT. COL. DAN ORMOND C.O.", is around the outer part.

The reverse side shows in the center "VIMY / 446717 / WALTER / LOUDON" and around the outer part "8:30 A.M. APRIL 9, 1917 / JACK NUTTALL RSM" (regimental sergeant major).

Specimens of this wood are available from Walter Loudon, 1498 Joy Road, Mascouche Heights, Quebec, J7L 2K3, for a stamped self-addressed envelope.

**A message from Walter A. Loudon C.D.  
a veteran of the Fighting 10th Bn, now living in Quebec**

To all the members of the CALGARY HIGHLANDERS & VISITORS:

It is with deep regret that I am not able to be present on this 82nd Anniversary of the 103 CALGARY RIFLES 10TH CANADIANS AND THE CALGARY HIGHLANDERS, and wish to thank the Regiment for inviting me to send this short story of my service with the Calgary units.

In 1912, I joined the 103 CALGARY RIFLES under Lt. Col. Armstrong. At that time I was still in High School and member of the Boy Scouts under Scout Master A. T. Jewett.

When war broke out August 1914, I tried to enlist, but was told

.....

MESSAGE FROM WALTER A LOUDON C.D. (Cont'd)

that I was too young. However in May 1915, I was able to enlist in the 56th Calgary Regiment for active service still under Lt. Col. Armstrong. The rest of that summer we trained at the new Sarcee camp under canvas.

The winter 1916, we spent in the building of the fairgrounds, Victoria Park. Later to become the Stampede Grounds.

Early in 1916, we left Calgary, embarking at Halifax and landing at Plymouth with more training at Dibgate Camp (near Folkstown). Later I was sent to the 10th Bn in time to see service on both the Somme and Vimy Ridge.

Wounded, I was returned to England where I spent the rest of the war as an instructor.

I tried twice to return to the 10th but was told I was more valuable training new men coming from Canada.

When war finished I was returned to Canada and served for a year in Calgary in M.D. 13 under Col. George Pearks V.C. issuing war service badges.

When I was discharged my work took me away from Calgary. So I was not able to join the CALGARY HIGHLANDERS when they were formed

Again I thank you for the honor of being remembered by the Regiment.

Walter A. Loudon C.D.

\*\*\*\*\*

The "Northern Ontario Collectors' News", published by Letterpress of Dowling, Ontario, is a new monthly bulletin or newsletter for collectors of coins, tokens, medals, stamps, plates, figurines, records, bottles, postcards, comic books, memorabilia of mining and railway, books, dolls, figurines, antiques, and sports cards. Right now most articles are on stamps and coins.

Started by Joe Schneider as the "Sudbury Stamp Trade", it was expanded in its fourth issue (September 1992) to include coins with Jeff Fournier of Sudbury, Ont., as the editor of the coins, medals, tokens and notes section.

A one year subscription to this monthly publication is available at \$8.00. A sample copy is available at \$0.75 in cash or in unused U.S. or Canadian postage stamps, from % Northern Ontario Collectors News, 160 Arlington Drive West, Box 479, Dowling, Ontario, POM 1R0.

A classified ad section is a big feature of this publication. Minimal amount is \$2.50 for 20 words. Display ads also available. The publication will cover club news, shows, flea markets, antique sales and dealers in the Northern Ontario region.

The Sept. issue was 8 pages on 8½ x 11 inch pages with photos. The October issue will be 12 pages.

It is hoped that the publication will unite collectors of various interests in Northern Ontario as well as others in other parts of Canada, and of the United States who are interested in meeting coll-

.....

NORTHERN ONTARIO COLLECTORS NEWS (Cont'd)

ectors in Northern Ontario.

Future plans are for a guide to inform readers in the north of where various collectible dealers are situated and also flea markets. Collectible shows will be announced.

Letters to the editor, story ideas, club information, news, and views are welcome. Numismatic information may be sent to Jeff Fournier, P.O. Box 2111, Station A, Sudbury, Ontario, P3A 4R8.

A review by Jerry Remick

\*\*\*\*\*



PO Box 21104, Stratford, Ont N5A 7V4 (519) 273-1715

---

## *THE SECRETS OUT!!*

What you have been waiting for has finally arrived! Now you can have your wooden nickels, wooden commemoratives and wooden flats hot stamped using state-of-the art equipment.

No more extended waiting periods or the disappointment of poor quality stamping. You supply the design and wording and leave the rest to us. We prepare the dies, stamp the woods to your exact specifications and ship anywhere in Canada, the United States or for that matter most countries in the World.

CANADA WIDE WOODS is a partnership that was formed to fill a void in the manufacture of wooden coinage and flats. After experiencing lengthy delays in the delivery of the 1992 commemorative for the Stratford Coin Club and the uncertainty of future deliveries, three members of the Club felt there was an urgent need for a stable and delivery conscientious manufacturer. The partners, Bill Cousins, Larry Walker and Ken Wilnot have purchased the latest equipment, secured a reliable supplier of wooden blanks both 1 1/2" and 1 3/4" and are now ready to take your orders. We can also produce wooden flats, wooden business cards, and almost anything made of wood that needs to be stamped.

If you wish to order or require additional information please write to CANADA WIDE WOODS at P.O. Box 21104, Stratford, Ontario. N5A 7V4 or telephone us at 519 273-1715.

## *PRESS RELEASE*

File PR\_02.212

New Firm Leads With Innovative Approach.

CANADA WIDE WOODS announced a fresh approach to the collecting fraternity and charities. Ken Wilmot, one of the partners in the new Hot Stamping Company stated the firm would donate to named organizations 1 cent for every wood produced. Ken said the idea for the rebate system came from the successful merchandising giants Zehrs and Sobeys. Both these companies have a cash register tape rebate plan. CANADA WIDE WOODS idea is that any person placing an order for any amount of wooden pieces can designate a Club, Society or recognized Charity.

In the days of computers, keeping track of these credits will be an easy task and whenever any Club etc. goes over 5,000 credited strikes a cheque will be sent to the Club for the equivalent of 1 cent for each piece struck.

Easily followed examples are:

Canadian Numismatic Association reaches a total of 5500.

They would receive a cheque for \$55.00.

Ontario Numismatic Association reaches a total of 5100.

They would receive a cheque for \$51.00.

When asked why a new firm would take such an approach, Ken was quick to point out that success in business depends on the goodwill of its customers and this would be the firms way of thanking the collecting fraternity for their support.

Ken went on to say that CANADA WIDE WOODS was dedicated to a quality product with reliable service at a reasonable price.

For information on CANADA WIDE WOODS, you can contact the firm through their Postal Box 21104, Stratford Ontario. N5A 7V4 or phoning 519 273-1715.

## *PRESS RELEASE*

Canada Wide Woods has been appointed as the "OFFICIAL" supplier of Hot Stamped Woods for the 1993 Ontario Numismatic Association Convention to be held at the College Inn, Guelph. The Convention which runs from April 16 to April 18 at the College Inn, Stone Road and Gordon Street. Featured on the Souvenir Woods will be one of Ontario's Architectural Treasures, The Church of our Lady. The same subject will be used on the Convention Medals.

Personal dies, from anyone who have their own dies, can be mated with the "OFFICIAL" Convention die depicting one of the most famous architectural religious structures in Ontario. If you do not have your own die, one with your wording can be made up. The cost of making a die is \$20.00.

A "Users" fee of \$5.00 for the use of the "OFFICIAL" Convention die will be applied to orders with proceeds going to the Church of our Lady Restoration Fund.

The following prices will apply:

MIN. ORDER	100	.....	\$ 50.00	+	\$ 5.00	=	\$ 55.00
	200	.....	\$100.00	+	\$ 5.00	=	\$105.00
	250	.....	\$100.00	+	\$ 5.00	=	\$105.00
	300	.....	\$120.00	+	\$ 5.00	=	\$125.00
	500	.....	\$175.00	+	\$ 5.00	=	\$180.00

The "OFFICIAL" woods will be struck on 1 1/2" wood blanks using the Hot Stamped Foil process.

As the timing is critical, your immediate response is vital if you wish the woods prior to the Convention.



PO Box 21104, Stratford, Ont N5A 7V4 (519) 273-1715

## PRICE GUIDE

Quantity	1 1/2"	DIE	TOTAL	1 3/4"	DIE	TOTAL
100	\$ 50	\$ 20	\$ 70	\$ 60	\$ 20	\$ 80
150	\$ 75	\$ 20	\$ 95	\$ 90	\$ 20	\$110
200	\$100	\$ 20	\$120	\$120	\$ 20	\$140
250	\$100	\$ 20	\$120	\$125	\$ 20	\$145
300	\$120	\$ 20	\$140	\$150	\$ 20	\$170
400	\$160	\$ 20	\$180	\$200	\$ 20	\$220
500	\$175	\$ 20	\$195	\$225	\$ 20	\$245
1000	\$300	\$ 0	\$300	\$350	\$ 0	\$350
2000	\$600	\$ 0	\$600	\$700	\$ 0	\$700
5000	\$1400	\$ 0	\$1400	\$1650	\$ 0	\$1650

**DIES** For Personalized Dies Attach Copy or show on reverse.  
For LOGOS, special artwork etc. please include camera ready copy.  
Estimated cost of a Die - \$20.00  
Any changes of dies or colours to original order, \$10.00 per change.

**SPECIAL FOIL** For Multi coloured "FIESTA FOIL" add .02 per unit.  
HOLIGRAM FOIL if available add .05 per unit

**2" HEART** For 2" Wood Hearts add \$10.00 per 100 to 1 3/4" price.

**SHIPPING** Will be made in the most expeditious and economical manner and will be added to the invoice.

**TAXES** Applicable Taxes will be added.

## DREAM VACATION REPORT

Ken Wilnot requests you to "BRING 'EM BACK DEAD"- meaning what? PLEASE RETURN the O.N.A. Dream Vacation Draw Ticket Stubs and money to him A.S.A.P. We need the support of the Members to make this another successful year. If you are not a ticket seller why not buy some for yourself? These are better odds than 649!



PO Box 21104, Stratford, Ont N5A 7V4 (519) 273-1715

## ORDER FORM

NAME \_\_\_\_\_ DATE \_\_\_\_\_

ADDRESS \_\_\_\_\_  
 \_\_\_\_\_

=====

Please supply me with the following;

	Brief Description	Colour	Cost
Quantity _____			_____
Die No. _____	_____	_____	_____
Die No. _____	_____	_____	_____
Deposit of 50% required with order			_____

### PRICE LIST

Price List Effective to June 30, 1993  
 Hot Stamped Foil Wood Rounds

	Price per 100		
Quantity	1 1/2"	1 3/4"	2" HEART
Min. Order 100	\$50.00	\$60.00	\$70.00
100-249	\$50.00/c	\$60.00/c	\$70.00/c
250-499	\$40.00/c	\$50.00/c	\$60.00/c
500-999	\$35.00/c	\$45.00/c	\$55.00/c
1000 +			
Includes die costs	\$30.00/c	\$35.00/c	\$45.00/c
5000 and over.	P.O.R.	P.O.R.	P.O.R.

**DIES** For Personalized Dies Attach Copy or show on reverse.  
 For LOGOS, special artwork etc. please include camera ready copy.  
 Estimated cost of a Die - \$20.00  
 Any changes of dies or colours to original order, \$10.00 per change.

**SHIPPING** Will be made in the most expeditious and economical manner and will be added to the invoice.

REF. \_\_\_\_\_

Signed \_\_\_\_\_

ONTARIO NUMISMATIC ASSOCIATION  
 31st ANNUAL CONVENTION AND COIN SHOW  
 COLLEGE INN, GUELPH ONTARIO  
 APRIL 16-18

\*\*\*\*\*

NAME \_\_\_\_\_  
 ADDRESS \_\_\_\_\_ TEL. # \_\_\_\_\_  
 CITY \_\_\_\_\_ PROV. \_\_\_\_\_ CODE \_\_\_\_\_  
 \*\*\*\*\*

QUANTITY	ITEM	COST PER ITEM OR PERSON	TOTAL
_____	CONVENTION PRE-REGISTRATION KIT Includes: Admission to Show, O.N.A. Draw Ticket, Full Bar Reception, Gold Plate Convention Medal, Con- vention Woods, Use of Hospitality Room, Penny Draw Tickets and much more.	\$ 25.00	_____
_____	PRE-REGISTRATION KIT Same as above except no Gold Plate Convention medal <i>Guarantee! If you are not completely satisfied with your Convention Kit, return Kit, receive your money back and Unlimited Free Admission to the Show!</i>	\$ 15.00	_____
	Friday, April 16th 9:00 p.m. Full Bar Reception, Included in Pre-registration Kit.		
	Unregistered Guests (Refreshments)	\$ 7.50	_____
	Saturday, April 17th, 9:30 a.m. Bus & Conducted Tour- Church of Our Lady, featured on Medallion Max. 25 Reservations only.	\$ 4.00	_____
	April 17th, 6:30 p.m. O.N.A. Banquet and Guest Speaker <i>Includes Post Banquet Reception</i> Rev. Roger McCombe is one of the finest speakers and we know that everyone attending will remember the evening for years to come.	\$ 25.00	_____
	Sunday, April 18th, 8:30 a.m. Club Delegates Breakfast.	\$ 10.00	_____
	Convention Medals .999 Silver	\$ 35.00	_____
	Antique Bronze	\$ 7.50	_____
	Gold Plate available only in Pre-registration Kits.		
		TOTAL	=====

Please make cheque or Money order Payable to O.N.A. Convention 93  
 and return with form to: P.O. Box 33, WATERLOO, Ontario. N2J 3Z6

Medals, Banquet and Delegate Breakfast INCLUDE taxes & gatuity.



# THE ONTARIO NUMISMATIST

OFFICIAL PUBLICATION OF THE ONTARIO NUMISMATIC ASSOCIATION

ISSN 0048-1815

VOL. 32 MAY-JUNE POST CONVENTION ISSUE PG.36/93

1993-1995

## O.N.A. OFFICERS

### Immediate Past President

G. Oblinski

### President

R. Zelk

### First Vice President

H. Farrow

### Second Vice President

T. Kostaluk

### Secretary

Vacant

### Treasurer & Membership

B. H. Raszmann

~~Box 33, Waterloo, N2J 3Z6~~

### Directors:

- Area:
- 1a R. Binder
  - 1b S. Hodge
  - 2 T. Masters
  - 3 R. Voaden
  - 4 R. Fletcher
  - 5 K. Wilmot
  - 6 E. Workman
  - 7 A. Kasman
  - 8 --
  - 9 B. Uman
  - 10 R. Albert

### Head Judge

E. Workman

R. R. #2 Cannington, Ont.  
LOE 1EO

### Speakers Circuit & Convention Co-Ordinator

T. Kennedy

### Audio-Visual Service

K. Koch

219 Southwood Dr.

Kitchener, Ont. N2E 2B2

### Librarian

T. Masters

823 Van Street

London, Ont. N5Z 1M8

### Editor

J. Fournier

138 Plumtree Cr.

Sudbury, Ont. P3B 4G6

## POWERED FLIGHT IN CANADA



## THE FIRST FIFTY YEARS



### CHANGE OF ADDRESS

P.O. BOX 40033, WATERLOO SQUARE P.O.,  
75 KING STREET, S.,  
WATERLOO, ONTARIO, N2J 4V1

↑ The ONTARIO NUMISMATIST is published by the Ontario Numismatic Association. The publication can be obtained with membership in one of the following categories: Regular Membership \$10.00 annually; Husband & Wife (one journal) \$12.00 annually; Junior (up to 18) \$3.00 annually. Life Memberships available for \$100.00 after 3 years of regular membership. Club Membership \$15.00. Remittances payable to the Ontario Numismatic Assoc., P.O. Box 33, Waterloo, Ont. N2J 3Z6

## PRESIDENT'S MESSAGE

So, another successful convention has come and gone. The last two conventions in Geulph were fantastic, with many reunions and a few new friendships. I just hope that the next two conventions are as successful. They will be held in North York in 1994 and in the city of Stratford in 1995. I hope my two year term will also be as successful and insperational as the last two conventions.

For those who do not know me, let me introduce myself. I am President of the NORTH YORK COIN CLUB, Ontatio director of CPMS, & Membership Chairperson of the Canadian Association of Wooden Money Collectors. I have also taken on the responsibility of being next year's Convention Chairman. So as you can see, my slate is full and I believe very rewarding. However, I have tried very hard with no result to fill the position of Secretary. If there is anyone who knows anyone who can help the ONA, please let me know. I will be more than pleased to let them help by being secretary.

The objective of the next two years is communications. If you have any questions or suggestions for the better of the hobby, I am open to them and I am sure my committee is as well. So, until the next time we meet, this is your President Ron Zelk hoping I can do the job as well as expected of me.

YOUR PRESIDENT, RON ZELK

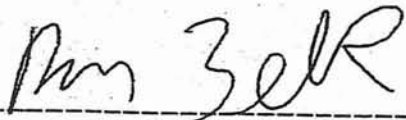
  
-----

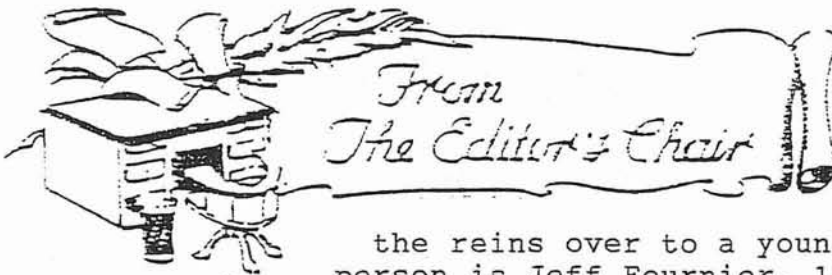

Since 1986 it's been a great learning experience and a position as O.N.A. Editor that I have enjoyed, but circumstances deem that I should move on and turn

the reins over to a younger, capable person. That person is Jeff Fournier, 138 Plumtree Crescent, Sudbury, Ontario, P3B 4G6.

Jeff is a very busy person....President, Editor of the Nickel Belt Coin Club, Editor of Northern Ontario Collectors News, just to name a couple of his duties. Beside these positions he holds a full time working position, and raising a young family. I'm sure the old familiar Numismatist will undergo a face lift in the near future. I wish Jeff all the success as he takes over the Position of Editor for the O.N.A. I'll give Jeff as much support as he needs with articles from time to time. I hope all those who supported me will do likewise.

What are my immediate plans...first I'm still President, Editor of the Ingersoll Coin News, President of Thames Valley Kiwanis Club until 1994, and President of the New Era Seniors, so I also have lots to do. At my age, and on the advice of my Doctor, he tells me to lighten the load. Also I plan to do some travelling...my feet get itchy and it's closed shop for a week or month at a time. Spare time will allow me to catch up with my family, my grandchildren, and one great grandchild. With just a blink of an eye they seem to grow up and move away.

Let's get back to the business at hand. They told me an Editor's job would be a lonely one, but I have had a wonderful co-operation from a number of people. I'll not mention all, but Bruce Raszmann deserves a pat on the back for the co-operation to me. Getting the master copies printed and mailed took a big load off my shoulders. Thank you Bruce. Jerry Remick was a familiar name that appeared in many of our issues, and I want to thank Jerry. Tom Kostaluk was another who supplied me with articles, and I thank you too Tom, and to the Presidents who put in their messages, and the Clubs who gave me their Show Dates, my sincere thanks....

Lonely....no it was an exciting time....sometimes frustrating.. but as I said earlier - a learning experience.

One person I forgot to mention was my wife Ida, who did all the typing and artwork. She deserves more than thank you...without her help, the O.N.A. Numismatist would have never seen the light of day.

We have now moved into the nineties, and with Jeff at the helm I'm sure the changes that take place in our publication will reflect the changes from the sixties to the nineties. Good luck Jeff...I hope your tenure lasts longer than my seven years, and are just as rewarding and exciting.....

T. Masters

\*\*\*\*\*

THE O.N.A. needs a Secretary, and Area 8 (Oshawa District) needs a Director.....Won't you consider offering your services?????

\*\*\*\*\*



# Communiqué

## POWERED FLIGHT IN CANADA / THE FIRST FIFTY YEARS

### NEW COINS SALUTE FAIRCHILD 71C AND LOCKHEED 14 SUPER ELECTRA

Ottawa (Monday, May 3, 1993): The Royal Canadian Mint unveiled the seventh and eighth coins in its 10-coin series celebrating the first fifty years of powered flight in Canada.

A maximum of only 50,000 of each coin will be sold worldwide. Each sterling silver coin contains a troy ounce of silver and is struck in proof finish with a 24-Karat gold-covered oval cameo. Each coin has a legal tender face value of \$20 and sells for \$54.35 CAN (\$46.50 US), plus applicable taxes and shipping charges.

The aviation coins are presented in an aluminum case shaped like the wing of an aircraft with a propeller design embossed on the lid. All coins are encapsulated for protection and come with a certificate of authenticity.

The new coins are the latest in a ten-coin series whose popularity has been steadily growing since its 1990 launch.

#### COIN SPECIFICATIONS:

Face Value- \$20, Diameter- 38mm, Finish- Proof only, Alloy- 92.5% silver, 7.5% copper/Sterling silver with 24-Karat gold covered oval cameo, Price- Single coin: \$54.35 CAN (\$46.50 US) (plus applicable taxes and \$ 4.00 shipping and handling per order). Prepaid subscriptions are no longer available from the Mint.

#### 1- THE FAIRCHILD 71C / James A. Richardson

Designed in 1932 mainly for civil use, the Canadian built Fairchild 71C was a seven-seat utility monoplane developed from the famous Fairchild FC-2. The Fairchild 71C model featured folding wings and an undercarriage that could be quickly changed over from wheels to skis or floats. This aircraft served mainly as freighter in Northern Canada and was occasionally used for photographic surveys, as well as for technical training by the R.C.A.F. during World War II.

The design on the reverse of the coin, by artist Robert R. Carmichael, depicts a Fairchild 71C landing on a northern lake. The gold-covered cameo portrays James A. Richardson founder and president of the newly formed Airways Limited in 1930. His active interest as well as his extensive contribution to the Canadian air transport industry led him to become director of several other aviation companies, including Fairchild Aerial Surveys Limited of Canada and Canadian Vickers Limited of Montreal. The obverse features the effigy of Her Majesty Queen Elizabeth II, designed by Dora de Pedery-HUNT.



.....

POWERED FLIGHT IN CANADA (Cont'd)2- LOCKHEED 14 SUPER ELECTRA / Zebulon Lewis Leigh

The Lockheed 14 Super Electra was developed to provide passenger and cargo transportation service. Although of smaller capacity than its competitor, the Douglas DC-3, it had exceptional cruise performance. It was designed with special features such as Fowler flaps and leading edge slots to improve take-off and landing performance. The first prototype was flown in July 1937, and it subsequently led to the wartime development of the Hudson/Ventura bomber series. On April 1, 1939, Trans-Canada Airlines (now Air Canada) inaugurated the first transcontinental passenger and air mail service using two Lockheed 14H2 models.



The design on the reverse of the coin, by artist Robert R. Carmichael depicts a Lockheed 14 in front of the Malton Terminal, near Toronto. The gold-covered cameo portrays Zebulon Lewis Leigh who was awarded the Trans Canada Trophy in 1946 for his exceptional achievement in both civil and military aviation. That same year, he was appointed Commanding Officer of the R.C.A.F. Station at Goose Bay, Labrador, where he served until 1948.

The obverse features the effigy of Her Majesty Queen Elizabeth II, designed by Dora de Pedery-HUNT.

For more information: Andre Girard  
Communications Manager  
Royal Canadian Mint  
(613) 993-0310 FAX; (613) 998-5472

\*\*\*\*\*

DELEGATES BREAKFAST?????

Slightly over 30 attended this Sunday, 8:30 a.m., breakfast meeting chaired by Past President of the C.N.A. John Regitko. Of those attending, 14 were O.N.A. Executive Officers. There was no speaker, and those attending were invited to put forth questions that could benefit Clubs and the Hobby.

Windsor's rep Ron Binder stated that their Club advertises their meetings - date- place- and time- to bolster attendance and membership. Mall displays was another method in getting the newd of Clubs to the public, and business cards passed out with all the information re metings, show dates, etc. for the year. This method is being used by several Clubs in Ontario with positive results.

Security was another topic, and it was noted the R.C.M. has placed a number on their packaging for identification.

C.N.A. Rep President Earl Salterio hoped that Coin Week or Coin Month might be revived in the future. This could only happen if more Clubs became involved.

O.N.A. Raffle Chairman Ken Wilmot reported that license for these raffles is becoming more difficult to obtain, certain cities and areas more difficult than others.

Best Bulletin Award Chairman T. Masters reported that the Huronic Numismatic Society was the 1992 winner.

# SHOW AND BOURSE

- June 13 BRANTFORD NUMISMATIC SOCIETY ANNUAL SHOW & BOURSE - Woodman Community Centre, 491 Grey Street. Brantford. Free Admission. Hours 8 a.m.- 5 p.m. Info: B.N.S., Box 351, Brantford, Ontario, N3T 5N3.
- June 26-27 (TOREX SHOW - Primrose Hotel, 111 Carlton St., Downtown  
October 23-24 (Toronto. Info: Ingrid K. Smith, P.O. Box 865, Adelaide (St. P.O. Toronto, Ont., M5C 2K1. Tel. (416) 586 0098.
- July 20-25 C.N.A. ANNUAL CONVENTION - Keddy's Brunswick Hotel, Moncton, N.B. Info: Moncton Coin Club, P.O. Box 54, Moncton, N.B., E1C 8R9.
- September 11 (HURONIA NUMISMATIC ASSOCIATION COIN, STAMP, ANTIQUE SHOW-  
February 5/94 (Bayfield Mall, Bayfield St. N., Barrie, Ontario. Info: (P.O. Box 243, Barrie, Ontario, L4M 4T2.
- September 12 WOODSTOCK COIN CLUB 4th ANNUAL COIN SHOW - U.A.W. Hall, Beale St., Woodstock. Info: Woodstock Coin Club, 549 Grace St., Woodstock, Ont., N4S 4N7. Hours 9 a.m.- 4 p.m.
- September 18 ST. CATHARINES COIN CLUB ANNUAL COIN SHOW - Russell Ave. Community Centre, 108 Russell Ave., St. Catharines. Info: St. Catharines Coin Club, P.O. Box 1492, St. Catharines, Ontario, L2R 7J9.
- September 19 LONDON NUMISMATIC SOCIETY SHOW-- Ramada Inn, Wellington Road at 401. Info: L.N.S., 543 Kininvie Drive, London, Ontario, N6G 1P1.
- September 24- 26 INTERNATIONAL COLLECTORS FAIR SHOW of Coins, Stamps, Postcards, Medals, Sports Cards, Sports Memorabilia, Paper Money - Skylon Tower, Niagara Falls. Hours... September 24- 1 p.m.- 9 p.m., September 25- 10 a.m.- 6 p.m., September 26- 10 a.m.- 5 p.m. Info: Call (416) 646 7744 - or by fax 416- 646-0995.
- October 2 HAMILTON COIN CLUB SEMI-ANNUAL COIN SHOW - Royal Canadian Legion, Branch 58, 1180 Barton St. E., upstairs, Hamilton, Ont. Hours 9 a.m.- 4 p.m. Free Admission.
- October 2 NORTH YORK COIN CLUB ANNUAL SHOW - 10 a.m.- 5 p.m. Edithvale Community Centre, 7 Edithvale Drive, North York. Free Admission. Info: North York Coin Club, P.O. Box 58508, Crnr Plaza P.O. 197 Sheppard Ave. E., North York, Ontario, M2N 6R7.
- October 3 SARNIA COIN CLUB SHOW - Canterbury Inn, 1485 London Road, Sarnia. Hours 10 a.m.- 4 p.m. Free Admission. Info: Carl Williamson. Phone (519) 337 9191.
- October 31 STRATFORD COIN CLUB ANNUAL COIN SHOW - Stratford Kiwanis Centre, Lakeside Drive, Stratford. Info: Stratford Coin Club, Box 21031, Stratford, Ontario, N5A 7V4.
- November 7 TILLSONBURG COIN CLUB ANNUAL COIN & HOBBY SHOW - Mount Elgin Community Centre, 5 miles south of 401 and 5 miles north of Tillsonburg on Highway 19 - exit south off 401 on Highway 19, Ingersoll-Tillsonburg exit. Info: W. Baxter, 46 Queen Street, Tillsonburg, Ont., N4G 3G9.

SHOW & BOURSE (Cont'd)

- November 14 WINDSOR COIN CLUB FALL SHOW - Knights of Columbus Mall, 1140 Goyeau St. Hours 9:30 a.m. - 5:00 p.m. Info: Ron Binder (519)254 6855, or 2279 Hall Ave., Windsor, N8W 2L8.
- November 27 WATERLOO COIN SOCIETY COIN SHOW - The Rink in the Park, Seagram Drive, Waterloo. Hours 10 a.m.- 5 p.m. Free Admission and Free Parking. Info: Don Robb, Box 724 Waterloo, Ont., N2J 4C2 (519) 888 9655.
- Second Sunday OTTAWA COIN, STAMP, DEALERS ASSOCIATION SHOW - Nepean  
Each Month Sportsplex, Woodsroffe Ave., 10 a.m.- 4 p.m. Info: Allan Davis, P.O. Box 307, Carp, Ontario, DOA 1L0.

NOTE:.....

- Received too late to be included in lineup.....
- June 4-6 WOODEN MONEY SHOW, Park Hotel, Niagara Falls

\*\*\*\*\*

# ASSOCIATION NEWS

## MEMBERSHIP

The applications for membership which appeared in the March-April issue of the Ontario Numismatist have now been accepted.

The following application has been received. If no written objection to this application is received, acceptance will appear in the next issue of the Ontario Numismatist.

1352 Ray Virtue Pembroke, Ontario

\*\*\*\*\*

DELEGATES BREAKFAST??? (Cont'd from Page 40)

Speakers Circuit Chairman Tom Kennedy presented engraved medals to six people who had spoken at least 3 times at various Coin Club meetings. Those six were...Terry Aitken, Bruce Brace, Stella Hodge, John Regitko, Don Robb, and Thomas Masters.

SUMMARY:-

Many Clubs were represented by an Executive member of the O.N.A. Let's make this a truly Club Delegate Breakfast and have ALL Clubs represented by someone other than an O.N.A. Executive member.

Submitted by  
T. Masters

\*\*\*\*\*

1993 O.N.A. AWARD OF MERIT

by Paul Johnson

The Award of Merit was introduced by the Ontario Numismatic Association at the initial Convention in 1962. The purpose is to give recognition to the person in Ontario who has made the greatest contribution toward the advancement of Numismatics. Since 1962 thirty prominent numismatists have been honoured by being presented with the Award of Merit. Some of these individuals have included such numismatists as Sheldon Carroll, Jim Charlton, Victor Snell, and last year's winner Bruce Brace.

The Province of Ontario has indeed been fortunate to have many hard working and dedicated numismatists down through the years.... and who have worked primarily for the love of the hobby. Few are chosen to receive the O.N.A. Award of Merit Medal.

The 1993 recipient has been a valuable contributor to Ontario numismatics. Having been involved in organized numismatics since the 1960s, he has given much of his free time to various organizations. He is known best for his involvement and collecting of Canadian Bank notes.

Before I list some of his numerous achievements in the numismatic field, I would like to announce the recipient of the 1993 Ontario Numismatic Association Award of Merit silver medal.

MR. WILLIAM H. McDONALD

Bill has had a long and storied history in numismatics and probably should have received this award many years ago. In 1964 he was the Founding President of the Canadian Paper Money Society and continued as Editor from 1970-1973. He has been the author of numerous articles, and as a lecturer on paper money, the history of Canadian banks and banknotes, care and preservation of paper artifacts, etc. He has spoken to groups throughout Ontario and continues to do so.



In 1971 Bill was instrumental in founding the J. Douglas Ferguson Historical Research Foundation, an educational charitable organization which funds research and the publication of books on Canadian numismatic subjects. He is the current Chairman of the Foundation. Bill was Co-Chairman of the 1972 C.N.A. Convention in Toronto and it was probably the most memorable numismatic Convention in the 1970's. In 1981 he was General Chairman of the International Paper Money Congress - InterPam '81 - the world's first international paper money Convention with 23 countries represented.

In 1990 Bill was instrumental in the formation of the Classical & Medieval Numismatic Society and that organization continues to thrive.

He developed a major banknote collection and library of books about banks and banking...probably one of the foremost in Canada. A few years back Bill developed an interest in collecting ancient coinage primarily those issued during the period from 100 BC to 100 AD. With that interest he was instrumental in the 1990 formation of the Classical & Medieval Society. Bill has received numerous medals for writing and exhibiting and in 1974 was awarded the J. Douglas Ferguson gold medal, the highest award of the Canadian Numismatic Association.

Bill McDonald has given greatly to our hobby of numismatics both in the Province of Ontario and throughout Canada.

I am pleased to present Bill with the 1993 O.N.A. Award of Merit silver medal.

\*\*\*\*\*

BEST CLUB BULLETIN AWARD

1993 marked the fourth year in which this Award has been given. Previous winners were Ingersoll Coin Club 1990, Nickel Belt Coin Club 1991, Timmins Coin Club 1992.

16 Clubs submitted their bulletins for the 1993 Award, and from those entries the Huronia Numismatic Society was judged the Best Club Bulletin for 1993. During the past year, Huronia changed editors - Bill Gage was editor for part of 1992 and Jim Willis took over for the remainder of the year. Congratulations to the Huronia Club for a fine publication.

Honourable Mention went to the Stratford and Waterloo Clubs for their bulletins.

In order to promote Clubs to produce a better publication, rule number one was that a Club winner would not be eligible to win again for three years. The previous three winners will once again be eligible in 94-95-96 - Huronia in 97.

\*\*\*\*\*

The Court of Honour Display consisted of 21 cases.  
Those who had Court of Honour Displays were as follows:

Norman Belsten - The Evolution of Canadian Wooden Money

Noreen Howcroft - World Paper Currency

Ross Irwin - Kitchener Waterloo Octoberfest Trade Dollars

Paul Johnson - Cathedral Medals and Blue Jays Medals

Thomas Kostaluk - Commemorative Medals of Pauline Johnson

Ron Zelk - Canada Paper Money Now & Past

All displayers received an engraved silver plated medal.

\*\*\*\*\*

LIBRARY REPORT:

It was 1976 when I became O.N.A. Librarian, and many changes have taken place since that time. Some who borrowed books those early years have passed beyond or no longer in the hobby. Cost of mailing books in '77 was just a few cents, while today's cheapest rates start at \$2.80 plus tax. That first year over 80 books were borrowed and despite many new volumes being added, the use of the Library continues to decline. It's very seldom that anyone requested a book to be sent through the mail. Many feel the postage both ways--minimum \$5.60 plus tax, is just too much. Today most of the borrowing is done from a selection of books I take to the Club meetings. I attend. Through this method 33 books were borrowed and returned. Many of those who borrow these books are not members of the O.N.A., but are members of a Club that is an O.N.A. member.

Several books were added to the Library since our last Convention, all through donations, and at this time I would like to thank the following donors: J. D. Ferguson Foundation, Royal Canadian Mint, Wm. (Bill) English (several cartons of Auction Catalogues, Club Newsletters, etc.), Charlie Springborn, O.N.A.- Thomas Kostaluk, Thomas Masters. It is through these donations that our Library continues to expand.

Because of space involved...my age...and the urge to travel and spend winters in a warmer climate, I have given the O.N.A. a 2-year notice of my resignation as their Librarian. It is my hope that it will not take 2 years for a replacement, and someone can be found as soon as possible.

T. Masters

\*\*\*\*\*

ONTARIO NUMISMATIC ASSOCIATION  
TREASURER'S REPORT

FOR THE PERIOD JANUARY 1, 1992 TO DECEMBER 31, 1992

GENERAL ACCOUNT

Petty Cash @ Jan. 1, 1992	\$ 12.86
Bank Balance @ Jan. 1, 1992 (General Fund)	\$ 2426.10
Bank Balance @ Jan. 1, 1992 (Library)	\$ 83.84
Bank Balance @ Jan. 1, 1992 (Audio Visual)	\$ 53.77

\$ 2576.57

\$2576.57

RECEIPTS

Memberships (Regular, Junior & Club)	\$ 2219.00
1992 Convention Net Profit	\$ 2948.28
O.N.A. Convention Draw	\$ 1825.72
Club Ticket Rebate	\$ 78.00
Advertising	\$ 50.00
Bank Interest	\$ 49.22
Premium U.S.A. Money	\$ 7.24
Donations	\$ 6.00
Use of Medal Dies	\$ 30.00
Presentation Boxes	\$ 40.00
O.N.A. Convention Advance (1992)	\$ 1000.00
Transfer From Contingency Account	\$ 800.00

\$ 9053.46

\$ 9053.46

EXPENSES

O.N.A. Publication "Ontario Numismatist"	\$ 3729.47
Postage	\$ 170.35
Printing	\$ 69.41
P.O. Box Rental	\$ 57.78
Delegate's (Executive) Breakfast	\$ 130.00
C.N.A. & A.N.A. Dues	\$ 65.82
Office Supplies	\$ 37.62
Partial (1991) Convention Loss	\$ 2195.00
Display Cases	\$ 1600.00
Photocopying	\$ 14.84
Telephone	\$ 16.05
Speaker's Circuit	\$ 7.64
Honorariums	\$ 600.00
Clock - Chas B. Laister	\$ 49.95
Engraving	\$ 9.60
Audio Visual - Cabinet	\$ 57.49
O.N.A. Convention Advance (1993)	\$ 1000.00
Transfer To Life Membership	\$ 500.00

\$10311.02

\$10311.02

Excess Receipts Over Expenses

Petty Cash @ December 31, 1992	\$ 14.94
Bank Balance @ December 31, 1992 (General Fund)	\$ 1223.95
Bank Balance @ December 31, 1992 (Library)	\$ 83.84
Bank Balance @ December 31, 1992 (Audio Visual)	\$ -3.72

\$-1257.56

\$ 1319.01

GENERAL ACCOUNT - BANK RECONCILIATION

Bank Pass Book Balance @ December 31, 1992	\$ 2304.07
(2) Outstanding Cheques	\$ 1000.00
Statement Bank Balance @ December 31, 1992	\$ 1304.07

ONTARIO NUMISMATIC ASSOCIATION  
TREASURER'S REPORT  
FOR THE PERIOD JANUARY 1, 1992 TO DECEMBER 31, 1992

## CONTINGENCY ACCOUNT

Bank Balance @ January 1, 1992 \$13031.57

## RECEIPTS

Interest Guaranteed Investment Certificates \$ 390.02  
Bank Interest \$ 279.67  
Matured Guaranteed Investment Certificate \$2000.00

\$2669.69 \$2669.69

## EXPENSES

Transfer To General Account \$ 800.00  
Short Term Certificate Of Deposit \$7000.00

\$7800.00 \$7800.00

Excess Receipts Over Expenses \$-5130.31

Bank Balance @ December 31, 1992 \$ 7901.26

## CONTINGENCY ACCOUNT ASSETS

Guaranteed Investment Certificate \$2000.23  
Short Term Certificate Of Deposit \$7000.00

## INSURANCE ACCOUNT

Bank Balance @ January 1, 1992 \$ 3346.69

## RECEIPTS

9 (1992) Club Premiums @ \$25.00 Each \$ 225.00  
2 (1992) Club Premiums @ \$35.00 Each \$ 70.00  
1 Additional Named Insured \$ 25.00  
7 (1993) Club Premiums @ \$25.00 Each \$175.00  
Bank Interest \$ 79.14

\$ 574.14 \$ 574.14

## EXPENSES

Insurance Premium \$ 350.00  
Photocopies & Postage \$ 19.24

\$ 369.24 \$ 369.24

Excess Receipts Over Expenses \$ 204.90

Bank Balance @ December 31, 1992 \$ 3551.59

ONTARIO NUMISMATIC ASSOCIATION  
TREASURER'S REPORT  
FOR THE PERIOD JANUARY 1, 1992 TO DECEMBER 31, 1992

CASH ASSET SUMMARY @ DECEMBER 31, 1992

Cash & Bank Balance - General Account	\$	1319.01	
Bank Balance - Contingency Account	\$	7901.26	
Guaranteed Investment Certificate - Contingency	\$	2000.23	
Short Term Certificate Of Deposit - Contingency	\$	7000.00	
Bank Balance - Insurance Account	\$	3551.59	
		\$21772.09	\$21772.09
Cash Assets (1991)			\$22955.06
Decrease In Cash Assets			\$ 1182.97

LIFE MEMBERSHIP ACCOUNT

Bank Balance @ January 1, 1992	\$1827.19
--------------------------------	-----------

RECEIPTS

Interest Guaranteed Investment Certificates	\$	497.06	
Bank Interest	\$	56.23	
Transfer From General Account	\$	500.00	
		\$1053.29	\$1053.29

EXPENSES

Membership Dues (1992)	\$	690.00	\$690.00
Excess Receipts Over Expenses			\$ 363.29,
Bank Balance @ December 31, 1992			\$2190.48

LIFE MEMBERSHIP ASSETS

Guaranteed Investment Certificates	\$4725.00
------------------------------------	-----------

The Bank Accounts are maintained at  
The Canada Trust, Belmont Branch  
Kitchener, Ontario.

Treasurer Bruce H. Rainmont

At the Annual Meeting on Sunday, April 18, 1993,  
this Treasurer's Report was approved by those present.

\*\*\*\*\*

RAILROAD MEDALS AND TOKENS  
by Dave Bennick

Many years ago I sold my entire coin collection, but I never lost my fascination for numismatics or coin collecting. I am also a railfan and as a result I have combined both interests and have been collecting railroad medals and tokens. Several years ago in an article in The Railroadiana Express titled "Railroad Coins - Medals - Tokens", Dennis Tacke showed pieces from his collection and discussed the many reasons railroads have issued medals and tokens. My collecting interests go a little further as I collect medals and tokens issued by railroads plus medals and tokens with a "rail theme" even though they may not have been issued by a railroad.

I have two collections. One is composed entirely of transportation tokens issued basically for fare purposes by trolley, bus, toll road, bridge, amusement ride and other local operators. These tokens of which there are thousands that have been issued are not within the scope of this article. My second collection is composed of, as the title suggests, railroad medals and tokens. As I started this second collection, I developed a rationale for the collection so that I would limit my efforts. I felt it was necessary to develop some rules that would keep me from collecting one of everything on display at a railroadiana show, a coin show or a flea market. I wanted a better collection of a smaller segment of railroadiana than bits and pieces of all possible railroadiana. All the pieces in my collection fall into one of the following groups:

1. Medals and tokens issued by, or commemorating an event related to a specific railroad. These would include railroad issued fare pieces, timetable pieces, passes, advertising pieces, souvenirs, merchandise tokens and drinking cup tokens.

The Burlington Northern medal was issued to highlight safety, the CP Rail medal was issued to celebrate an event, the Mount MacDonal Tunnel breakthrough, and the Pennsylvania medal was issued by The Mutual Beneficial Association to commemorate their 50th anniversary:

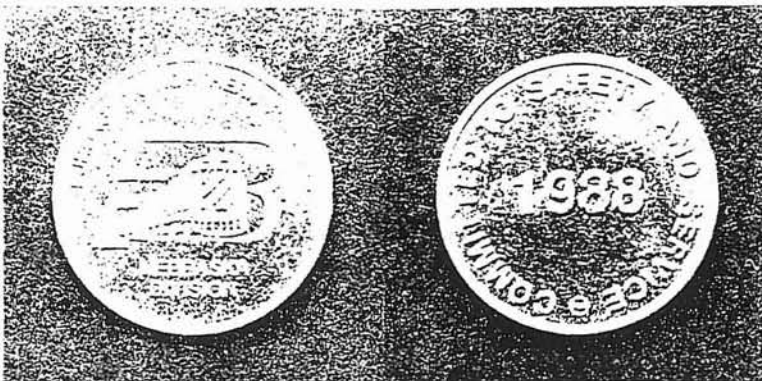

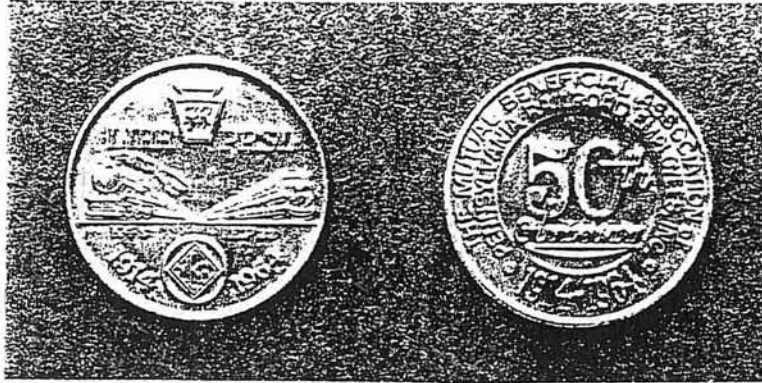

2. Medals and tokens issued by, or commemorating an event related to railroad suppliers or companies providing rolling stock, parts or services to railroads. Two examples are from EMD and Olcott & Brother:

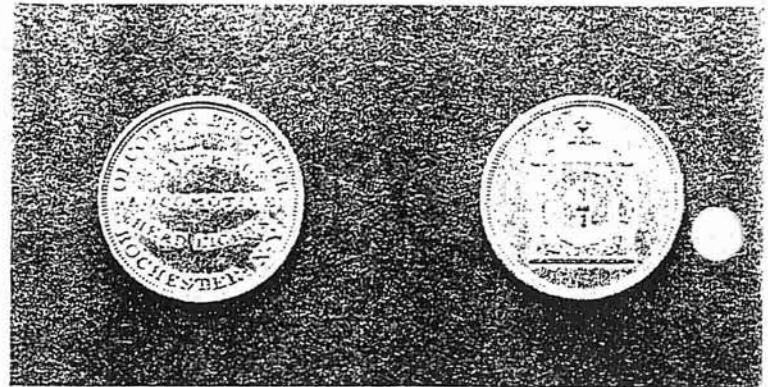
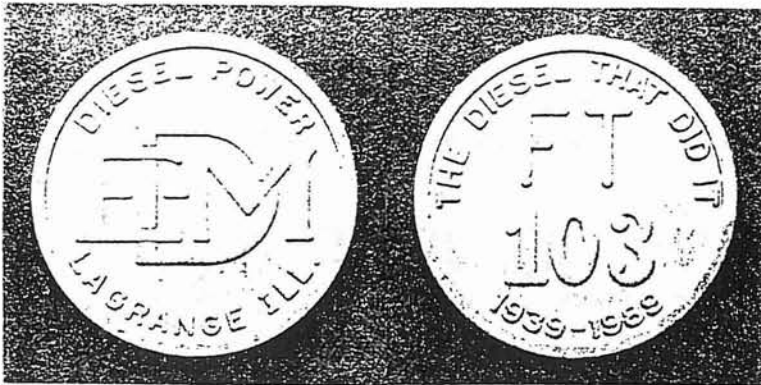

3. Medals and tokens commemorating an event of railroads in general, streetcars, trams, railroad bridges, railroad stations or museums. Included here are medals and tokens used for tours and as souvenirs by scenic lines, tourist lines, museums, clubs or other organizations. This group also includes medals on which a train, streetcar or other railed vehicle appears as part of the design, but which may not be related to a specific railroad or even railroads in general. I have found that many municipalities, clubs and other organizations include a train or a locomotive on at least one side when designing their commemorative or souvenir pieces, probably because of the widespread interest in trains and railroads.

The first medal illustrated in this group is one sponsored by the American Freedom Train Foundation, Inc. The medal was minted in 3 different sizes, 32 mm, 38 mm and 63 mm, depending upon which of six different metal varieties were purchased.

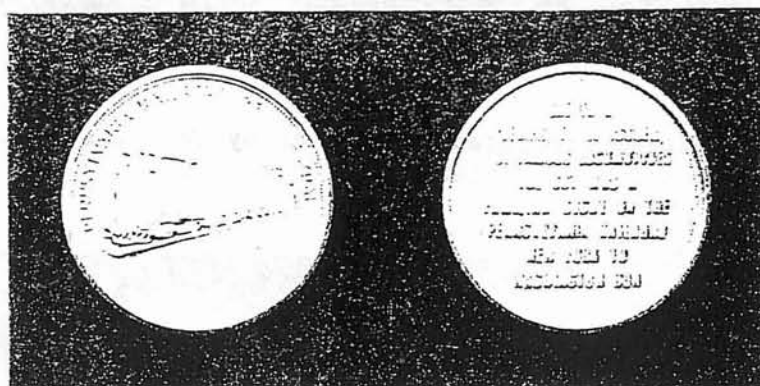
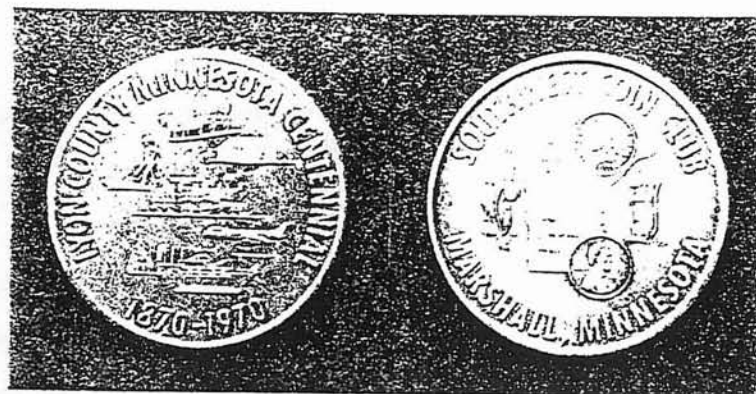
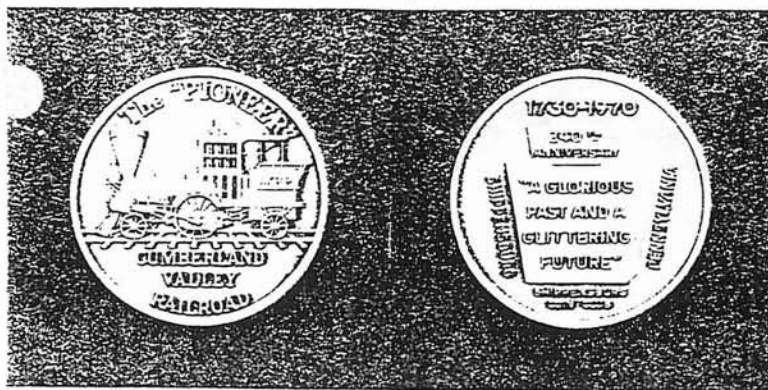

Many cities and towns have issued medals to celebrate an anniversary of the town itself, or the railroad passing through the town or a bridge, station or other structure:

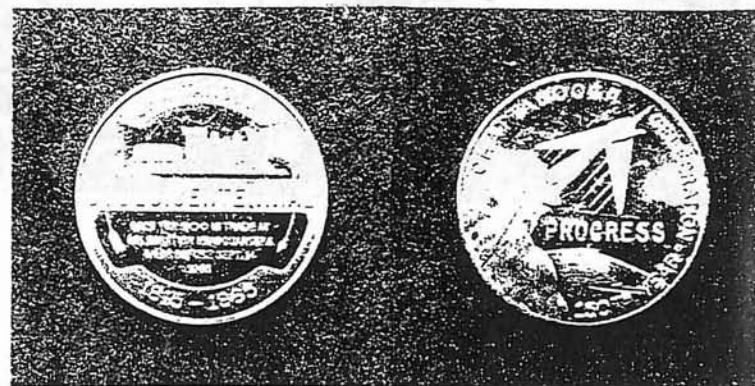
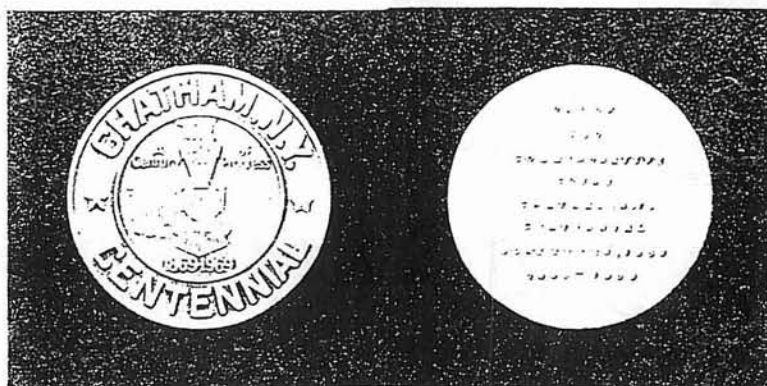

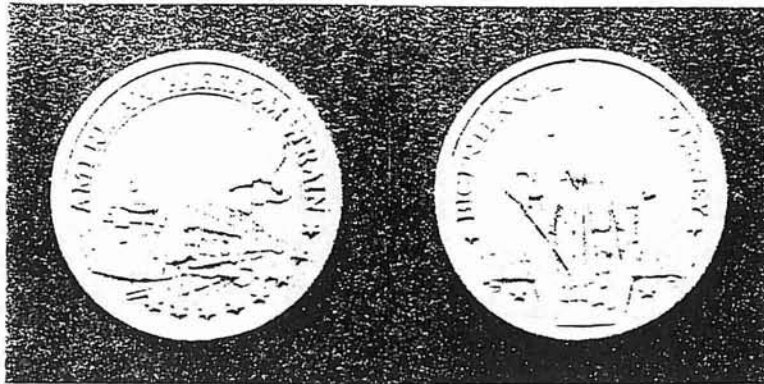

The next medal illustrated was issued by Longines-Wittnauer, Inc., probably as one of a series of collectibles:



Coin clubs issue annual medals to celebrate an anniversary, some historical event or their annual meeting:

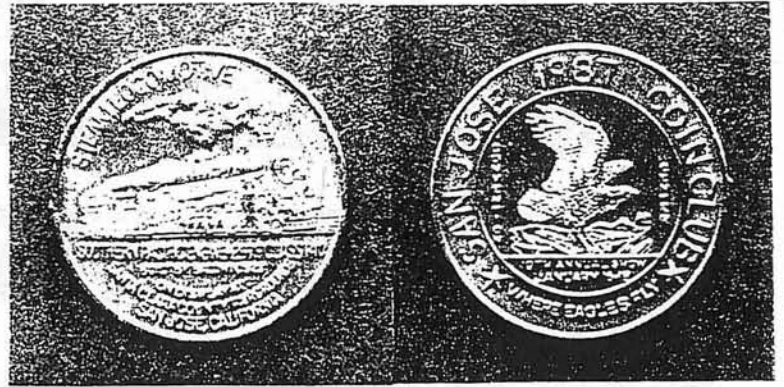
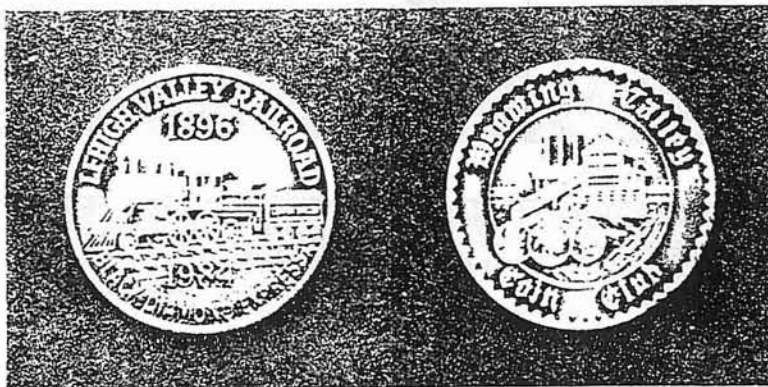

And, the last two illustrations are of medals issued as souvenirs by museums:

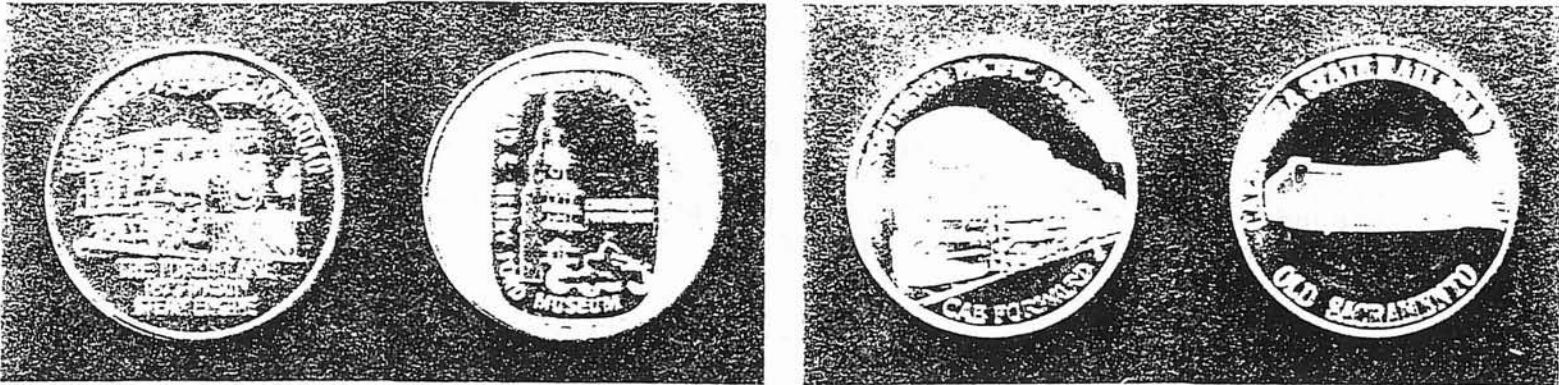

There is a fourth category as I also collect medals commemorating bridges that are not in fact used to carry railed vehicles and that have nothing whatever to do with railroads. I just happen to like bridges, but non-railroad bridges do not fall within the scope of RCAI.

My railroad medal and token collection is limited to those issued in the United States and Canada. I exclude government issued coins such as the Canadian \$1.00 coins of 1981 and 1986. Also excluded are speculative precious metal bars and ingots with generic train or locomotive images. These are difficult to attribute to a specific location and are usually not commemorative in nature.

At the beginning of 1991 I started to catalog the medals and tokens in my collection and those of a few fellow collectors with whom I regularly correspond. Cataloging anything seems like a simple enough task, but it has taken me over a year to complete the first edition of a catalog. When I started the catalog, I had about 120 pieces and at this point my collection contains 500 pieces. My listing (obviously I don't have them all) now has 990 different medals and tokens and if you count medals and tokens struck in different metals such as aluminum and bronze versions, an additional 349 pieces for a total of 1,339 medals and tokens. I have not yet seen the end of the cataloging effort. Each day the mail brings a rubbing or photo of a piece that I didn't know existed. I know there are others out there but I don't have any idea how many.

Prices of railroad medals and tokens fluctuate over a wide range just as they fluctuate for other segments of railroadiana. At railroadiana shows, some dealers try to hold their medals and tokens for ransom while other are more reasonable. At coin shows and flea markets prices are more reasonable with many bargains available. There are of course many older medals and tokens and many minted in solid gold and silver and the price of these stretches one's finances. In most instances where a medal or token is minted in a precious metal, there are one or more versions minted in copper, brass, bronze or white metal. The vast majority of these are priced under \$10.00 and many of the pieces issues by municipalities or as souvenirs can be purchased for 50¢ to \$3.00.

One never knows where a railroad medal will turn up as I have found them mixed with coins, in boxes of buttons or as a solitary piece with a dealer who has no other coins or pieces of railroadiana.

Part of the fun is finding new items either as a new addition to my collection or as a new addition to my listing. Another part of the fun is meeting new friends over the phone or through the mail and eventually face to face at a coin show or convention.

At this point I am not sure how many medals and tokens are out there waiting to be listed or collected, but my guess now is somewhere around 2,000 but there may be still more. The excitement of discovery always adds to "collecting fever."

\*\*\*\*\*

#### EDITOR'S REPORT

1992 O.N.A. Numismatist consisted of 7 issues for a total of 119 pages. Jerry Remick continued to submit articles, and one or more of his articles appeared in each issue. I would like to thank Jerry Remick and all others for their contributions.

Our Show & Bourse has expanded and Clubs have assisted by submitting their Show dates earlier than previously. Still a few problems in the Show & Bourse area.

Some of our feature articles were- "Transportation On Coins", "Guelph, The City That Owns a Railroad", "On My Mind- A Sudden Case Of Deafness", an article by an Ingersoll Junior- "Indian Head or Buffalo Type Nickel", "Sudbury Numismatics", "Pauline Johnson-- Canadian Indian Poetess", "Type Collection of Canadian Coins", "A Nickel's Worth of Fraud & Mystery", "The Kiwi and The New Zealand Decimals", were some of the feature articles. Did a profile on Charlie Laister and Harry Spice. Editorials appeared in each issue, and drew some comments pro and con.

Letters to the Editor were more than past years, and appeared when received. Events were noted especially the Mint's Coin Exchange and The Dutch Mint's issues of the 1992 Silver Ducat. On a whole, I thought our 1992 issues were quite informative, with the information that was supplied.

#### IMPROVEMENTS:-

Our publication should have a President's Message, more articles from O.N.A. Executive, and Members....possibly a whole new format, if funds will allow....Continue to improve our Show & Bourse if Clubs will participate....Club worthwhile news but should be submitted by Clubs to Editor....and finally....more information on the O.N.A. Conventions, so our Convention issue can truly become a CONVENTION ISSUE.

T. Masters, Editor

\*\*\*\*\*

## ONTARIO NUMISMATIC ASSOCIATION

BOX 33, WATERLOO, ONTARIO, CANADA N2J 3Z6



FOUNDED - 1962

D R E A M   V A C A T I O N

1993

DRAW WINNERS  
List

First Prize      A Travel Voucher for \$1,250.00 that can be used  
for any destination or travel arrangement through  
ROBERT Q's TRAVEL MART, Stratford, Ontario.

JEANNE CHERRY WATERLOO, ONTARIO

Sellers Prize (\$100.00 Cash)

HAIG DOUGLAS

Second Prize      A Canadian 1987 \$100.00 Gold Coin

G. VANSTEIT, LONDON, ONTARIO

Five Consolation Prizes of a Canadian Prooflike Set and a Years  
Membership in the Ontario Numismatic Association.

Winners-----	JAMIE BART	STRATFORD, ONTARIO
	STEVE PLAYTER	BRAMALEA, ONTARIO
	WILLIAM JAREMA	STRATFORD, ONTARIO
	JOHN KRYSTIA	SUDBURY, ONTARIO
	JIM COPE	BRAMPTON, ONTARIO

Special Draw      From the Ticket Sellers for a Consolation Prize as  
noted above.

BILL BAXTER

TILLSONBURG, ONTARIO

The Ontario Numismatic Association would like to thank all those  
who sold tickets or purchased them. Your support enables us to  
carry out our many programmes.

Thank you

*Kenneth W. Wilmot*  
Kenneth W. Wilmot,  
Draw Chairman.

DREAM VACATION

1993

## L O T T E R Y      R E S U L T S

## Ticket Sales by Clubs

Club	Books Sold
Brantford Numismatic Society	1
Cambridge Coin Club	3
Champlain Coin Club	3
Guelph Coin Club	8
Hamilton Coin Club	8
Huronian Numismatic Association	3
Ingersoll Coin Club	68
Kent Coin Club	1
Lakeshore Coin Club	1
Lake Superior Coin Club	6
London Numismatic Society	4
Mississauga Coin Club	13
Nickel Belt Coin Club	13
Nippissing Coin Club	1
North York Coin Club	34
Ontario Numismatic Society	24
Oshawa Coin Club	4
Ottawa Coin Club (City of)	9
Peterborough Coin Club	4
Polish American Numismatic Society	1
Sarnia Coin Club	1
Scarborough Coin Club	6
St. Catharines Coin Club	3
St. Thomas Coin Club	6
Stratford Coin Club	94
Tillsonburg Coin Club	47
Toronto Coin Club	1
Waterloo Coin Society	51
Windsor Coin Club	5
Woodstock Coin Club	5
Woodville Coin Club	7
C.A.W.M.C.	2
C.T.C.C.C.	20
C.N.A.	3
	=====
Total Book Sales	460

T R E N D S B E M I D C A N A D A C D M  
 O P S L L O R O P R O O F L L E S O S O  
 K A B A G B U Y O A N C I E N T L S E N  
 E P O Q O R A R E K G R A D E L C H T E  
 N E B U L C D E A L E R L D A B A O S Y  
 S R R A Y P L A T I N U M R D U T W M N  
 L S S R M W O R L D S L I D E L A D E I  
 E A I T P V A R I E T Y R E D L L I D C  
 V U L E I P A T I N A R R C G I O E A K  
 I C V R C O I N O T E P E O E O G S L E  
 T T E H O B B Y T I L L T E Y N U S S L  
 A I R E V E R S E N E A T E D A E M T C  
 R O R E S T R I K E E T Y N H E L A R O  
 O N B U S I N E S S T E P F G C D R I P  
 M I N T L E G E N D S D E M I I N G K P  
 E P M A T T E R C O L L A R U E E A E E  
 M R K A R A T R D E N A E L C L L R L R  
 M I N T A G E O O B V E R S E G E D O P  
 O C C A M E O R R E L I E F B L A N K F  
 C E N T U N C I R C U L A T E D E L A S

Find the following words in the above puzzle and circle the letters. After you find all the words there will be 10 letters remaining. Write the letters down in order from the top and find the secret word.

ADD  
 ANCIENT  
 AUCTION  
 BAG  
 BLANK  
 BOOK  
 BOURSE  
 BULLION  
 BUSINESS  
 BUY  
 CAMEO  
 CANADA  
 CATALOGUE  
 CENT  
 CLEANED  
 CLUB  
 COIN  
 COLLAR  
 COMMEMORATIVE  
 COPPER  
 DEALER  
 DIES  
 DIME  
 DOLLAR

EDGE  
 ERROR  
 FIELD  
 FOREIGN  
 GRADE  
 GRAMS  
 HOBBY  
 KARAT  
 LEGEND  
 MATTE  
 MEDAL  
 MINT  
 MINTAGE  
 MONEY  
 MULE  
 NICKEL  
 NOTE  
 OBVERSE  
 OLYMPIC  
 PAPER  
 PATINA  
 PLANCHET  
 PLATED  
 PLATINUM

PRICE  
 PROOF  
 QUARTER  
 RARE  
 REEDED  
 RELIEF  
 RESTRIKE  
 REVERSE  
 RIM  
 ROLLS  
 ROYAL  
 SALE  
 SELL  
 SETS  
 SHOW  
 SILVER  
 SLIDE  
 STEEL  
 STRIKE  
 TOKENS  
 TRENDS  
 TYPE  
 UNCIRCULATED  
 VARIETY  
 WORLD

SUBMITTED BY: DAVID BAWCUTT, President  
 Scarborough Coin Club



# ONTARIO NUMISMATIST

OFFICIAL PUBLICATION OF THE ONTARIO NUMISMATIC ASSOCIATION  
ISSN 0048-1815

VOLUME 32 JULY/AUGUST PAGE 57-93

## O.N.A. OFFICERS

### IMMEDIATE PAST PRESIDENT

G. Oblinski

### PRESIDENT

R. Zelk

### FIRST VICE PRESIDENT

H. Farrow

### SECOND VICE PRESIDENT

T. Kostaluk

### SECRETARY

Vacant

### TREASURER & MEMBERSHIP

B.H. Raszmann

### DIRECTORS

Area 1a: R. Binder

Area 1b: S. Hodge

Area 2: T. Masters

Area 3: R. Voaden

Area 4: R. Fletcher

Area 5: K. Wilmot

Area 6: E. Workman

Area 7: A. Kasman

Area 8: Vacant

Area 9: B. Uman

Area 10: R. Albert

### HEAD JUDGE

E. Workman

R.R. #2 Cannington, Ont.,

LOE 1E0

### SPEAKER CIRCUIT AND

### CONVENTION

### COORDINATOR

K. Koch

219 Southwood Dr.

Kitchener, Ont., N2E 2B2

### LIBRARIAN

T. Masters

823 Van Street

London, Ont., N5Z 1M8

### EDITOR

J. Fournier

P.O. Box 2111, Stn. "A",

Sudbury, Ont., P3A 4R8

## MEMBERSHIP

REGULAR MEMBERSHIP,  
\$10.00/Yr.; HUSBAND & WIFE  
(ONE JOURNAL), \$12.00/Yr.;  
JUNIOR (UP TO 18) \$3.00/Yr.; LIFE  
MEMBERSHIP (AFTER 3 Yrs.  
REGULAR MEMBERSHIP), \$100.00;  
CLUB MEMBERSHIP, \$15.00.  
Remittances to: THE ONTARIO  
NUMISMATIC ASSOCIATION, P.O.  
BOX 40033, WATERLOO SQUARE  
P.O., 75 KING ST. SOUTH,  
WATERLOO, ONTARIO, N2J 4V1.

## HAPPY BIRTHDAY CCN

1993 marks the 30th anniversary of Canadian Coin News. Through the years, its name has changed, from "Canada Coin News" to "Coin Stamp Antique News" and finally to its present day "Canadian Coin News". Along with name changes came a number of changes in ownership as well.

From its modest beginnings have sprung several sister publications including "Insight On Collectibles", "Canadian Stamp News" and most recently "Canadian Sportscard Collector".

Since 1963, 'Coin News has covered the major events in Canadian and world numismatics along with offering insightful articles on coins, tokens, and medals.

It has served as a medium for dealers wishing to reach prospective collectors with advertisements of coins for sale, and for collectors, especially those far-removed from larger centers, to acquire Numismatic treasures through mailorder.

CCN was there during the high and low points of numismatics - the speculative craze in '64 and '65; the release of the '67 Centennial year coinage, the bear market, brought on perhaps, by the removal of silver from Canadian Coinage in 1968; the opening of a new RCM facility in Winnipeg in 1974, the sale of the renowned 1911 silver dollar in 1976 to an American dealer; the investor surge of the 80's and of course, the beginning of what may well be the decade of the true collector - the 90's.



I have been a coin collector for 20 years...but my collecting interests also include numismatic books, periodicals, auction catalogs and an extensive collection of CCN issues including Volume 1 #1. These represent some of the most precious possessions in my collection. They provide me with insight on the coin market of the past, ideas for articles, information and facts for my research. My CCN collection is priceless to me.

The ONTARIO NUMISMATIC ASSOCIATION extend our congratulations to CCN and wish its publisher, Paul Fioca, and staff, continued success. Let's hope

that at least another 30 years of successful hobby coverage is in the cards for CCN...Happy Birthday!★

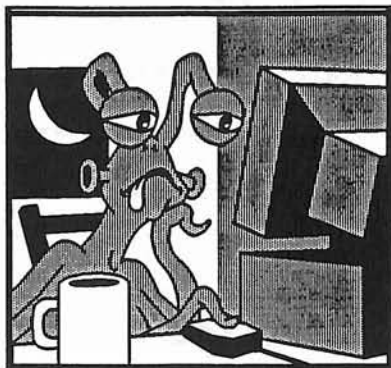

CAUTION! EDITOR AT WORK

# EDITOR'S VIEWS

Welcome to the new look "ONTARIO NUMISMATIST". I am pleased to have been chosen as the editor for our organization, and hope that I can fill the capable shoes of Tom Masters, who so competently edited the ONTARIO NUMISMATIST since 1986.

On behalf of myself and all present and past ONA members, who've enjoyed your work in this newsletter over the years, we thank you, Tom! Thanks for all the years of hard work and we wish you a happy "2nd retirement".

Of course, anyone who knows Tom also knows that he never really retires. He will always be occupied in one club or another. And of course, you can all rest assured that his retirement as editor for the ONTARIO NUMISMATIST doesn't mean we've seen the last of him.

Tom has assured me (and I'll hold you to this, Tom) that he'll be making the odd contribution to this newsletter in the form of feature articles and so forth. And you can bet Tom will continue to show up at the annual ONA conventions. Again, Tom, thanks for all your hard work!



Now, it's time for me to introduce myself. My name is Jeff Fournier and I've been involved in this hobby since 1971, though only since the early '80's, have I been a serious student of Numismatics.

I'm 30 years old (and an April fool!), live in Sudbury, work for Ontario Hydro as a control room operator, and have a wife, Shelly, and two children: Alisha (age 3 1/2) and Brennan (9 months).

I must admit that the majority of my time is spent with my family and any time left over is dedicated to work and coin collecting - though not necessarily in that order!

As far as my numismatic involvement is concerned - I'm President of the Nickel Belt Coin Club and Editor of its newsletter; Editor of Northern Ontario Collectors' News; Editor of the Northern Ontario Numismatic Journal; contributing writing for Canadian Coin News; a Fellow of the Canadian Numismatic Research Society; and a member of the CNA, ONA, CATC.

In 1990, I published a catalog entitled "Ontario Municipal and Commemorative Medals", and have written a number of articles for the journals and newsletters of the above mentioned organizations.

What do I collect? Nearly anything Canadian - coins, municipal tokens, medallions, currency and Canadian Tire coupons. I am particularly interested in commemorative medallions and am working on a catalog covering medallions issued by Canadian coin clubs (any help from ONA members would be appreciated!).

I look forward to bringing you, the members, an interesting and informative newsletter during my tenure, and welcome articles, letters, comments, criticisms etc...



You'll notice that the newsletter has taken on quite a new look. I am using an IBM compatible computer to set the newsletter up and a Hewlett Packard laser printer, to print it up. Using a computer greatly speeds up the process and allows changes to be made with ease (though many times, I spend hours revising and tend to take on the appearance of the fellow at top!)

If you have articles, news, views and so forth to send in and have an IBM compatible, just send me your disk (any wordprocessor format will do). If you don't...no worry, just make sure what you send to me is legible. I'll take care of the typing. REGARDS! JEFF FOURNIER

# PRESENTATION AND COLLECTOR COINS OF THE ROYAL CANADIAN MINT

BY AL McQUISTIN

Since the time of its opening in 1908, the Royal Canadian Mint has produced both "collector" and "presentation" coin sets. Collector coins are pieces which are struck for sale to the general public. Modern day issues include the proof and specimen sets sold by the mint. In contrast, presentation coinage is that which is made for VIP's such as visiting dignitaries rather than for public sale. Generally, the existence of presentation coinage is not officially acknowledged by the mint and no mention is made of it in the mint's annual reports to parliament. In view of the latter, it is not surprising that the history of Canada's presentation coinage is extremely vague and 83 years after the RCM minted its first coinage, we are still learning of the existence of previously unknown specimens.



In the United States, the situation is quite the opposite. For example, books are available which depict pictures and mintage figures for U.S.A. proofs dating back 160 years. In Canada, we are lacking hard data on VIP sets produced as recently as 15 years ago. Fortunately, in the case of collector coins, the RCM has always kept records so we are not completely in the dark regarding this "special" coinage.

The first collector coinage to be made in Canada was in 1908 to celebrate the opening of our mint. In that year, approximately 1,000 specimen sets were struck and sold to the public for \$2.00 each. Unlike the pieces minted for general circulation, these coins were made using fresh dies, polished coin blanks and a double striking procedure in slow moving presses. This method of manufacture resulted in coins with high, sharp details and none of the roughness and marks evident on business strikes. As well, the coin surfaces evince a frosted, "satin" (ie: matte) appearance that is more glittering and more uniform than that on conventional strikes.

The official term given to these special coins of 1908 was "specimen" quality and not "proof". The RCM felt that these coins were unworthy of the term "proof" since they weren't up to the standard of Britain's Royal Mint proofs. In fact, the RCM lacked the facilities to make proof coinage until 1973. As a result, our first proof coins were the 1976 silver and gold Olympic coins and our first proof double dollar set was not made until 1981.

At this point, the distinction between "specimen" and "proof" coinage needs to be made. It should be noted that both are a method of manufacture that possess more in common than they do differences. In both cases, the procedures mentioned earlier (ie fresh, polished dies; polished coin blanks; slow moving presses; double strikings) are used to produce a superior looking coin. As well, both specimens and proofs can be made with three different surfaces:

- 1) MATTE (OR GRANULAR)
- 2) MIRROR (FULLY BRILLIANT OR MONO-TONED)
- 3) CAMEO (FROSTED DEVICES AGAINST A MIRROR BACKGROUND OR TWO-TONED)



The difference between proof and specimen lies in the degree of quality control. Proofs are meant to be flawless, state of the art coins with no imperfections of any kind. As a result, they are struck in dust free rooms and carefully inspected for quality. Specimens do not receive the same rigorous treatment and consequently the difference in quality between two specimen pieces tends to be greater than that between two proof pieces.

Returning to type of surface, most proofs from a given country are struck with a cameo surface (such as our current proof sets) but examples with matte or brilliant surfaces do exist. With regards to specimen coinage, the type of surface depends upon the time period in which the piece was struck. For example, in Canada, the breakdown is as follows:



- A) 1908 to 1936: matte finish
- B) 1937 to 1939: matte & mirror finish
- C) 1940 to 1944: mirror finish
- D) 1945 to 1970: cameo finish
- E) 1971 to date: mirror finish



Going back to the 1908 specimen coinage, the RCM also minted 636 1908 gold sovereigns in December of that year. All of these were specimen quality. The following year, a small number of 1909 sovereigns were struck in specimen quality.



After 1908, the next set of specimen coinage available to the public was in the spring of 1912. At that time, one could buy a silver and bronze set of 1911 coinage for \$2.00 or an expanded version containing a 1911 sovereign, a 1912 five dollar gold piece, and a 1912 ten dollar gold piece. This larger set of 8 specimen coins sold for \$24.00. Interestingly, some of the leather cases for both of these sets had a slot for the



anticipated 1911 silver dollar and these cases command a premium price.

In the period of 1913 to 1936, collector coins for public sale were unavailable but accumulating evidence indicates that individual presentation pieces and sets were made. One of the more desirous sets from the period is that of the 1921 specimen set whose value is approaching the \$200,000 mark.

With the coronation of King George VI in 1937, the RCM issued 1,295 specimen sets in cardboard boxes to the public at a price of \$3.25 each. These sets have a matte finish. A smaller number of presentation specimen sets were also made and these have much more eye appeal since they have cameo surfaces and are housed in a leather case.



The period of 1938 to 1948 was again one in which no sets were offered for public sale although small numbers of presentation sets were regularly produced. However, 1949 marked a turning point for it was in that year that the mint initiated attempts to provide high calibre coins to the public on a more accessible basis. 1949 was the birth year of the "proof-like" silver dollar and by 1951 proof-like pieces were also found in the 50 cent and 25 cent denominations (proof-likes have a mirror finish but are struck by the die only once). If you

ordered year sets from the mint between 1949 and 1952, you received your coins in individual cellophane envelopes stapled together inside of a small, white cardboard box. Usually, these coins were circulation strikes that never hit the mint bags. But if you were lucky, some of the pieces were proof-like.

Beginning in 1953, the mint became more systematic in its provision of coins to the public since that year initiated production of complete proof-like sets instead of random pieces.

While the mint geared up its facilities for the production of proof-like coinage, it continued to strike special presentation sets of specimen quality. The years 1949 to 1953 inclusively saw the production of presentation coins



in leather cases for VIP's. However, based upon evidence to date, the years 1954 to 1963 saw either no production of specimen sets or possibly the production of extremely small numbers of such coinage. The 45th (1991) edition of the Charlton catalogue lists no specimen coinage between these dates but future issues may do so.



VIP specimen sets were definitely made in the years 1964 and 1965. Again, no mention is made of these in the mint's annual reports. For 1966, only specimen silver dollars have surfaced to date. Of course, 1967 saw the widescale production of Centennial specimen sets. No information is available for 1968 but at least two VIP sets were struck in 1969. In 1970, Pierre Trudeau embarked on a tour of the Far East and took with him close to 1,000 specimen sets in leather cases to give away as gifts to dignitaries. After the trip about 100 of these sets remained and



were sold by the mint at the 1970 C.N.A convention in Halifax for \$13.00 each. This was done to gauge the public's interest in specimen sets.

The mint must have been pleased with the public's response because 1971 saw the production of mirror-finish specimen sets for general sale on an annual basis (ie: double dollar sets of 1971 to 1980). As mentioned previously, the quality of these double dollar sets was upgraded to cameo-finish proofs in 1981. For VIP's, at least in the years 1971 to 1976, the mint continued to issue specimen presentation sets housed in long, narrow leather cases usually black or red in colour. Mintage figures are always below 100 for any given year.

And so we have the fascinating history of RCM presentation and collector coinage to date. Hopefully the years ahead will shed more light on the area of the elusive VIP sets.

## WHAT DO YOU THINK?

Don't be shy! Let's hear what you think about the changes in the "Ontario Numismatist". What did you like? What didn't you like? Is there anything you'd like to see in future editions? What types of articles would you like to see?

Let us know what you want. Remember, this is **YOUR** club and this newsletter is for **YOUR** benefit.

In upcoming editions, the format may be changed somewhat with different features added and others deleted...depending on your response.

One thing being considered is a classified section. Would anybody like to see this? After all, we collectors like nothing more than buying and selling coins.

Letters to the Editor? Sure, we'd love to hear from you. And don't forget, we can only include information in here that's sent to us. If we don't know about it, neither will anyone else. Don't be afraid to keep us up-to-date on what's going on in your club.

Tell us about your shows, your meetings. Or let us know what you think about the coin hobby in general. And by all means, let us know if the O.N.A. are serving your needs.

We're also in need of articles for the "Ontario Numismatist". Contributions would be greatly accepted. How about submitting interesting articles from your club newsletter. I'm sure collectors from other clubs would benefit by the expertise of others. Keep in touch!



Put your pen to paper - tell us what you think!

# ONTARIO COIN CLUBS

**NOTE:** I would like "Ontario Coin Clubs" to be a semi-regular feature of the Ontario Numismatist. If your club would like to be featured here, send me information about how the club was started, who was involved, what you do at your meetings, your logo and so forth. You may write it up yourself, or I could write it for you...as long as all pertinent details are included. Also, if your club has issued a medal, token or other numismatic item, include details (mintage figures, photocopy, compositions, reason for issue etc...).

## THE NIPISSING COIN CLUB

The Nipissing Coin Club was formed in March of 1985 by a group of enthusiastic coin collectors in North Bay.

It brought together those interested in buying, selling and trading coins. It also offered an informal atmosphere where members could discuss their collections, their knowledge and share in the fun with others having the same interests. The club crest embodies the club's philosophy: "the stylized letters, "NCC" unite to represent friendship and trust existing in membership; it shows strength and value in its likeness to a piece of precious or

semi-precious metal used in the many numismatic pieces collected and studied by club members." Members do not necessarily have large collections. And emphasis is placed on acquiring knowledge and appreciation for a coin as opposed to emphasizing its value.

Meetings are informal and include collectors of all types of material such as coins, municipal tokens/medallions and currency. A modest membership fee is collected yearly, though children under 12 can join for free and students are given a reduced rate.

The club meets the 1st and 3rd Thursday of every month at 7:30 P.M. in the boardroom of Cassellholme - a local Senior Citizens home - 400 Olive St. North Bay.

The club is small, with only about 10 members, but they are probably some of the most devoted collectors in Ontario. Often, meetings are frequented by 100% of the membership.

Frequently, the club has displays at local malls, libraries and so forth.

They have also hosted a number of "Cub and

Guide nights" where the club helps youngsters earn their collector badges, while fun is had by all.



Anyone interested in more information can write to the editor (Jeff Fournier, P.O. Box 2111, Sudbury, Ont., P3A 4R8).

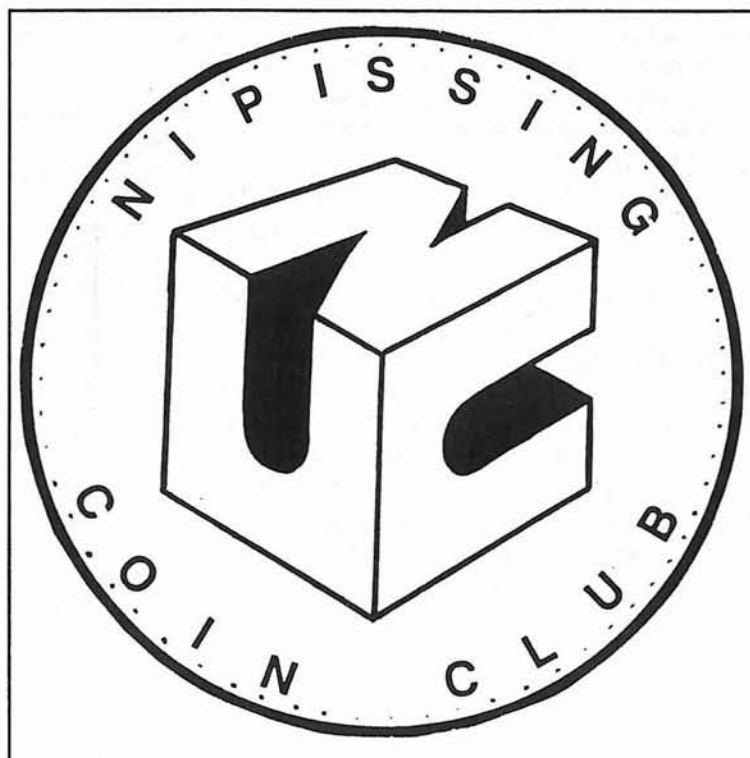

# JERRY'S CORNER

## PERSONALIZED MEDALS AVAILABLE

Each year, beginning with 1985, I have, with the permission of the O.N.A., made a small quantity of medals with the yearly O.N.A. convention die on one side and my own personal die on the other side. Three finishes were used: copper, gold plated copper and silver plated copper. I still have medals available in the three finishes cited above for 1985-1993. Send \$3.25 for each medal ordered or \$9.25 for 3 to **JERRY REMICK, BOX 9183, STE FOY, QUEBEC, G1V 4B1.**



*Jerry Remick*



## NEW EDITION OF CATALOGUE ON CANADIAN MEDALS

A new and improved format has been used, at my suggestion, for an updated version (1993) of the catalogue "CANADIAN MEDALS & RELATED ISSUES" (2nd edition), by **HARVEY SMITH, P.O. BOX 75126, SEATTLE, WASHINGTON, 98125-0126.**

The catalogue is printed on 8.5" X 11" pages. Improvements for the 2nd edition include a spiral binding and wider margins on each page so the left part of the printed page is not covered by the binding.

Over 6500 Canadian medals are catalogued on 104 pages - first by province and then by the issuing municipality. The following data is given for each piece: municipality in which the piece was issued, date, diameter, mint, metal, edge type, weight and a brief description.

This improved version of the 2nd edition was sent free of charge to all who purchased the 1st version of the 2nd edition. It is available for \$20 Canadian (to Canadian residences) and \$20 U.S. (for U.S. residences). The author is continually updating his listing and has over half the medals listed in his catalog in his collection.



*Jerry's personal die*



*Examples of medals covered in Harvey's book.*

# ORDERING COINS BY MAIL

By Jeff Fournier



Many mail-order coin firms offer a varied assortment of materials for the advanced and beginning collector. The use of their services can be an excellent way to purchase coins which otherwise may have been impossible to obtain.

Most dealers who sell by mail are honest and knowledgeable. But, as in any business, there exists a handful who are not. We collectors should take special precautions to guard against these unscrupulous few. By following the guidelines listed here, you will greatly reduce your risks when ordering by mail.



## BEFORE ORDERING COINS

A quick glance through numismatic magazines, newspapers and coin club journals will yield a number of dealers offering coins for sale. Take the time to jot down the type of coins they offer. What type of materials do they specifically deal in: Canadian coins, foreign, medals or tokens? Keep a list of the dealers who supply the type of materials which you may be interested in. Write several dealers requesting their latest listing explaining what your collecting interests are. Many dealers keep separate listings for the specialized collector.

Ask others if they have ordered from any of the dealers which you may be considering: what were their experiences like? Were they satisfied with the product received? Was it accurately graded and as described in the pricelist? Take note whether or not the dealer is a member of the Canadian Association of Numismatic Dealers (CAND).

Before placing an order, ensure that you are familiar with the item you are about to purchase. In other words, do not order a coin by description alone. It may sound interesting in the dealer's price-list, but it may not be so interesting once you receive it. If you are unsure about a specific piece, refer to a catalogue on the subject so that you may educate yourself before purchasing it. In other words, do your homework!

## TEST THE SERVICE

Initially, it is best to order in smaller quantities and from several dealers. In this way, you can "test" the dealer's services and merchandise. Keep records of how well the firm deals with you: how long did the coins take to arrive? Are the coins as described and properly graded? Was the dealer courteous and willing to help you with your collecting interests? What kinds of services can he offer - want list services, approvals, subscription service? If you are disappointed with the material or the service you received remember, it is better to find this out now before you have spent too much money purchasing materials from this particular dealer. Once you have weeded out the "bad apples" you are now ready to deal with a few trusted companies or individuals. A number of suggestions for ordering are offered below.



## GENERAL GUIDELINES

There are three things which should be remembered anytime you decide to purchase coins by mail:

- 1)The best price is not always the best deal. Don't be fooled by claims of "spectacular sale prices" or "rare coins at bargain prices". Remember, as with most anything else, you get what you paid for.
- 2)Don't send cash. Use your credit card when possible. It is much more difficult to get refunds once a cheque is cashed. With a credit card, you have more time to stop payment should something go wrong with your order (Don't expect to use credit- cards when ordering bullion, as many dealers will not accept them in this instance). If credit cards cannot be used, or if you prefer not to use them, send a money order, personal cheque or certified cheque (personal cheques should not be used when ordering from foreign addresses).
- 3)Call first for large purchases or to get confirmation that prices are as listed in the advertisement and material is in stock.

## PHONE ORDERS



When you place your order for coins over the telephone, I would offer the following suggestions. 1)Record the company name, address, phone number, date and time of the call on a piece of paper.

- 2)State exactly what coins or supplies you want
- 3)Ask if the item is in stock; if not, get a date when it will be available. If a firm answer is not given, try another dealer unless you have done business with this particular firm before (and are satisfied with the service) or you are aware that the materials you are ordering are scarce and difficult to obtain without some effort. In such cases, many dealers will scan the marketplace for you. He/she usually has many contacts and perhaps will be able to find the coin for you.
- 4)If the item is available, ask what its cost will be including taxes, shipping, insurance and so forth. Also ask about acceptable methods of payment and expected delivery date.
- 5)Get the name of the person you are talking to for later reference. Perhaps you may be interested in dealing with this particular individual again if you are satisfied with his/her service.
- 6)Have the person taking the order repeat it to you so that any errors may be caught before mailing.
- 7)Give your telephone number - especially on large purchases - in case problems arise.
- 8)Ask about the return/refund policy etc...Is a refund possible if the items are damaged during shipment or not as described.
- 9)Ask who you should correspond with in the event of difficulties.
- 10)Save any correspondence associated with your order including cancelled cheques, a copy of the money order, or any written confirmation sent by the seller.

## WHEN ORDERING BY MAIL

When ordering is done through the mail rather than over the telephone, these guidelines may be followed:

- 1)State clearly what it is you would like to order.
- 2)Read all instructions carefully regarding shipping costs, type of payment accepted and return policy.
- 3)Indicate whether or not you will accept alternate selections in the event that the dealer is sold out of the item you have requested.
- 4)Be sure to include your name, address, and postal code on all correspondence, not just the mailing envelope.
- 5)Keep a copy of your order and any correspondence from the dealer including cancelled cheques, sales slips and shipping receipts.

## WHEN SHIPMENT IS RECEIVED

Once you have received your order, check it immediately to ensure that no damage was done enroute and that all coins and supplies are as described in the advertisement. If possible, get a second, unbiased opinion from a coin club member concerning the grading of the coin. Better yet, when buying expensive materials through the mail, insist on coins graded by professional grading services.

**\*NOTE\*** Do not remove the coin from its original container as received from the dealer until you are sure that it is the item you have ordered. Many dealers have the policy that once a coin is removed from the casing which they have supplied, it will no longer be accepted for refund or exchange.



## IF PROBLEMS ARISE

Many dealers will let you return items for a full refund or credit if done so within a certain period of receipt (often 10 to 30 days). Sometimes however, an order is not received within the specified time. When this happens, notify the seller (after a reasonable waiting period). In many cases, it may simply be an honest mistake on the dealer's part.

When reporting the incident, refer to your order by description, order date, price and so forth. If you complain by phone, follow up with a letter to confirm what was discussed. If you receive no reply, try sending a registered letter. In all cases keep a record of dates on which you sent correspondence or made a phone enquiry.

Having tried all of the above steps without success, approach the newspaper or magazine where the advertisement was placed. In many instances, they can be of some help. At the least, if other complaints are filed by unsatisfied customers, the dealer may be barred from placing advertisements in that publication.

## PROS AND CONS

Obviously, there are many advantages as well as disadvantages to ordering coins by mail. Advantages include accessibility of materials to collectors who live in small communities and may not have coin dealers in town.

Secondly, it is a very convenient form of shopping for those who prefer to shop from home or are simply unable to make it to coin shops. This is especially true of the elderly and disabled individuals who collect coins.



The one advantage which far outweighs the others, is in the collector's opportunity to shop around from many different dealers throughout the world in order to find that handful who may deal in their particular specialty. Nothing is more frustrating than going to a dealer to look for a particular item(s), only to come out empty-handed because his stock of such materials may be non-existent or too small for your liking. This is especially true for those who collect medals, tokens, paper money and so forth. Most of the dealers who specialize in these areas do in fact, sell almost exclusively through the mail.

Of course, mail-order is not for everyone and does have several disadvantages over shopping in person. Most obvious of course is that you cannot see the coin before you purchase it. This is disadvantageous for those individuals who are shopping for mintstate items.

There are also the other frustrating problems which often arise including mail strikes, slow mail delivery and lost or damaged merchandise.

As a final piece of advice, "Caveat Emptor" - let the buyer beware!



# A WORD ABOUT MINT SETS

By Jeff Fournier

**H**ave you ever stopped to think just how much you're paying for those fancy cases from the Royal Canadian Mint - the ones housing the annual proof double dollar sets, and more recently, the silver Canada 125 coins? We may have no way of knowing for sure, but a reasonable estimate might be \$15 or \$20 - and perhaps more for the commemorative 25 cent set.

Are you as a coin collector really interested in paying this kind of money for a fancy box?

Maybe, or maybe not. That's up to you to decide. But for many years, the RCM has been making the decision for us. We've been given no choice at all in the matter.

Oh yes, the boxes are nice. But are they there merely to protect the coins, or as just another fancy marketing tool, designed to woo the unwary buyer.



## WHAT DO COLLECTORS WANT?



Perhaps the Mint has misjudged the wishes of the collector. Have they ever asked us what we want?

I'm betting that if they did, a good number of collectors would tell them that what they're really after are the coins - and not the cases they come in.

Wouldn't it be nice to buy the proof set encapsulated, perhaps, in a styrene holder - minus the expensive case...and the expensive price!

What would be wrong with that?

The consumer could still be given the choice as to whether he would like the case or not. At least then, it wouldn't be forced on him.

Unless your collecting is extremely limited, or you're buying the coins as a gift or for display purposes, there is little use for a large elaborate case. After all, the proof sets as they are available now are too bulky to permit easy storage in a safety deposit box. And this is where many end up, or should end up, for security reasons.

In fact, there are many collectors who remove the coins from the packaging the minute they receive them. It would simply be too impractical and expensive to try to store all those coins in all those cases in a safety deposit box or a home safe.

Surely the RCM could look into this matter and **ask** collectors what it is **they** want.

What do the rest of you think?

# SHOW & BOURSE

---

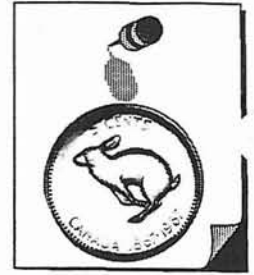

## **JULY 20-25 - C.N.A. ANNUAL CONVENTION**

Keddy's Brunswick Hotel, Moncton, N.B., Info: Moncton Coin Club, P.O. box 54, Moncton, N.B., E1C 8R9.

## **SEPTEMBER 11 - HURONIA NUMISMATIC ASSOC. COIN, STAMP, ANTIQUE SHOW \*\*\*\*\*CANCELLED\*\*\*\*\***

## **SEPTEMBER 12 - WOODSTOCK COIN CLUB 4TH ANNUAL COIN SHOW**

U.A.W. Hall, Beale St., Woodstock. Info: Woodstock Coin Club, 549 Grace St., Woodstock, Ont., N4S 4N7. Hours 9 a.m. to 4 p.m.

## **SEPTEMBER 18 - ST. CATHERINES COIN CLUB ANNUAL COIN SHOW**

Russell Ave. Community Centre, 108 Russell Ave., St. Catherines. Info: St. Catherines Coin Club, P.O. box 1492, St. Catherines, Ont., L2R 7J9.

## **SEPT 19 - LONDON NUMISMATIC SOCIETY SHOW**

Ramada Inn, Wellington Road at 401. Info: L.N.S., 543 Kininvie Dr., London, Ont., N6G 1P1.

## **SEPTEMBER 24-26 - INTERNATIONAL COLLECTORS FAIR SHOW**

Coins, stamps, postcards, medals, sportscards, sports memorabilia, paper money - Skylon Tower, Niagara Falls. Hours: Sept.24 from 1 p.m. to 9 p.m.; Sept.25 from 10 a.m. to 6 p.m.; Sept.26 from 10 a.m. to 5 p.m. Info: call (416)646-7744 fax (416)646-0995.

## **SEPTEMBER 25 - SCARBOROUGH COIN CLUB MALL DISPLAY**

Coin display and information session at the Cederbrae Mall from 9:30 a.m. to 4 p.m. Info: Scarborough Coin Club, P.O. box 465, West Hill, Ont., M1C 2P0.

## **OCTOBER 2 - HAMILTON COIN CLUB SEMI-ANNUAL COIN SHOW**

Royal Can. Legion, Branch 58, 1180 Barton St., E., upstairs, Hamilton, Ont. Hours: 9 a.m. to 4 p.m. Admission free.

## **OCTOBER 2 - NORTH YORK COIN CLUB ANNUAL SHOW**

10 a.m. to 5 p.m. Edithvale Community Centre, 7 Edithvale Dr., North York. Free Admission. Info: North York Coin Club, P.O. box 58508, Cnrn. Plaza P.O. 197 Sheppard Ave. E., North York, Ont., M2N 6R7.

## **OCTOBER 3 - SARNIA COIN CLUB SHOW**

Canterbury Inn, 1485 London Rd., Sarnia. Hours: 10 a.m. to 4 p.m. Free Admission. Info: Carl Williamson - (519)337-9191.

## **OCTOBER 31 - STRATFORD COIN CLUB ANNUAL COIN SHOW**

Stratford Kiwanis Centre, Lakeside Dr., Stratford. Info: Stratford Coin Club, Box 21031, Stratford, Ont., N5A 7V4.

## **NOVEMBER 7 - TILLSONBURG COIN CLUB ANNUAL COIN & HOBBY SHOW**

Mount Elgin Community Centre, 5 mile south of 401 and 5 mile north of Tillsonburg on hwy. 19 - exit south off 401 on hwy. 19, Ingersoll-Tillsonburg exit. Info: W. Baxter, 46 Queen St., Tillsonburg, Ont. N4G 3G9.

## **NOVEMBER 14 - WINDSOR COIN CLUB FALL SHOW**

Knights of Columbus Mall, 1140 Goyeau St. Hours: 9:30 a.m. to 5 p.m. Info: Ron Binder 9519254-6855 or 2279 Hall Ave., Windsor, N8W 2L8.

## **NOVEMBER 27 - WATERLOO COIN SOCIETY COIN SHOW**

The Rink in the Park, Seagram Dr., Waterloo. Hours 10 a.m. to 5 p.m. Free Admission and Free Parking. Info: Don Robb, P.O. box 22062, Westmount Postal Outlet, Waterloo, Ont., N2L 6J7.

## **SECOND SUNDAY EACH MONTH - OTTAWA COIN, STAMP, DEALERS ASSOC. SHOW**

Nepean Sportsplex, Woodsroffe Ave., 10 a.m. to 4 p.m. Info: Allan Davis, P.O. box 397, Carp, Ont., D0A 1L0.

\*Send info. regarding shows, displays, special club events to: **JEFF FOURNIER, P.O. BOX 2111, STN. "A", SUDBURY, ONT., P3A 4R8.** Next deadline for the Sept./Aug. issue of the "Ontario Numismatist" is Sept. 1/93\*

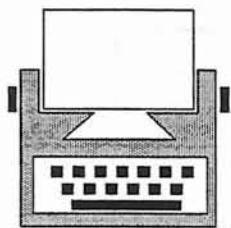

# **CLUB NEWS**



### **HURONIA NUMISMATIC ASSOCIATION**

Due to some unfortunate circumstances, the club's coin, stamp and antique shows have been cancelled. In the June edition of the "Huronian", the club's newsletter, President Ken Prophet explains how the club was unable to come to a mutual agreement with the management of the Bayfield Mall in Barry where the show had been held previously.

Also reported that 23 were present at the May meeting. Congratulations were extended to William Gage and Jim Willis, editors of the club newsletter, for capturing 1st place in the ONA newsletter of the year competition.

### **INGERSOLL COIN CLUB**

The June Newsletter mentioned that the club continued to sign up new members during the 1st half of 1993, but that rising costs have resulted in a small deficit for 1993. However, the club was still able to donate \$1200 to the Kiwanis disabled children's fund. The newsletter included a comical article entitled "Wacky Coin Stories". Plans for the June meeting included snippets from the club's 25th anniversary booklet, strawberries, cake and ice cream and an auction.

### **NICKEL BELT COIN CLUB**

The June meeting of the Nickel Belt Coin Club was attended by 22 people. Members were reminded that the club would be breaking for the summer, with meetings resuming once again in September. Several members brought displays in, with the highlight being an MS-60, 1908 25 cent piece and a beautiful collection of paper money. As usual, a 65 lot auction was held and collectors had plenty of time to mingle and discuss coins on an informal basis.

### **NORTH YORK COIN CLUB**

The June meeting was to feature a numismatic quiz, compliments of Paul Johnson. Members were also reminded in the bulletin that there would be no July meeting or bulletin. The May meeting was attended by 22 members. The evening was declared Numismatic reference night with many members bringing in numismatic books and periodicals: among them were - early Charlton catalogs, CNA auction catalogs, some early Somer James catalogs and many more. The next meeting is scheduled for August 24th.

### **TIMMINS COIN CLUB**

The Timmins Coin Club Newsletter for the month of June was chalk full of interesting articles and tidbits of info., along with reports on correspondence received, past meetings and upcoming events. Next meeting...July 13/93.

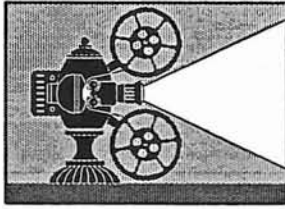

# THE

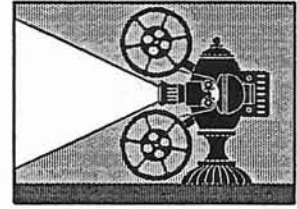

# LATE EDITION

*OOPS!! These last few items were sent in a little late to be included in the regular sections. From here on in "THE LATE EDITION" will be featured on the last page of this newsletter and will carry info. that was sent in too close to press time.*

*To ensure that I get your material on time please send it in by the middle of the month prior to publication (example: next edition is for September/October....have your material in by mid-august). My absolute maximum deadline will be the 1st of the month of publication (Sept. 1 for the next edition). This will ensure that you get the "ONTARIO NUMISMATIST" on time. Many Thanks!!*

## SHOW & BOURSE

### **OCTOBER 9/93 - OSHAWA & DISTRICT COIN CLUB COIN, TOKEN AND PAPER MONEY SHOW**

To be held at the Pickering Town Center from 10 a.m. to 5 p.m. For info. call (416)728-1352 (after October 4 dial area code 905) or write to the Oshawa & District Coin Club, P.O. Box 212, Oshawa, Ont., L1H 7L1.

## MEMBERSHIP

The application for membership which appeared in the May-June issue of the Ontario Numismatist has been accepted.

The following applications have been received. If no written objection to these applications are received, acceptance will appear in the next issue of the Ontario Numismatist.

1353 Bill Baxter, Tillsonburg, Ontario  
1354 John Krystia, Sudbury, Ontario  
1355 Earl MacLean, Oshawa, Ontario



# ONTARIO NUMISMATIST

OFFICIAL PUBLICATION OF THE ONTARIO NUMISMATIC ASSOCIATION  
ISSN 0048-1815

VOLUME 32 SEPTEMBER/OCTOBER PAGE 71-93

## O.N.A. OFFICERS

### IMMEDIATE PAST PRESIDENT

G. Oblinski

### PRESIDENT

R. Zelk

### FIRST VICE PRESIDENT

H. Farrow

### SECOND VICE PRESIDENT

T. Kostaluk

### SECRETARY

Vacant

### TREASURER & MEMBERSHIP

B.H. Raszmann

### DIRECTORS

Area 1a: R. Binder

Area 1b: S. Hodges

Area 2: T. Masters

Area 3: R. Voaden

Area 4: R. Fletcher

Area 5: K. Wilmut

Area 6: E. Workman

Area 7: A. Kasman

Area 8: Vacant

Area 9: B. Uman

Area 10: R. Albert

### HEAD JUDGE

E. Workman, R.R. #2 Cannington,  
On., L0E 1E0

### SPEAKER CIRCUIT & CONVENTION COORDINATOR

Tom Kennedy, 54 Trinity St.,  
Stratford, On., N5A 4P4

### AUDIO VISUAL

K. Koch, 219 Southwood Dr.  
Kitchener, On., N2E 2B2

### LIBRARIAN

T. Masters, 823 Van Street  
London, Ont., N5Z 1M8

### EDITOR

J. Fournier, P.O. Box 2111, Stn. "A",  
Sudbury, Ont., P3A 4R8

## MEMBERSHIP

REGULAR MEMBERSHIP,  
\$10.00/Yr.; HUSBAND & WIFE (1  
JOURNAL), \$12.00/Yr.; JUNIOR  
(TO 18) \$3.00/Yr.; LIFE  
MEMBERSHIP (AFTER 3 Yrs. REG.  
MEMBERSHIP), \$100.00; CLUB  
MEMBERSHIP, \$15.00.  
Remittances to: THE ONTARIO  
NUMISMATIC ASSOC., P.O.B.  
40033, WATERLOO SQUARE P.O.,  
75 KING ST. SOUTH, WATERLOO,  
ON., N2J 4V1.

## A COMING OF AGE

BY R.E. (RAY) DESJARDINS

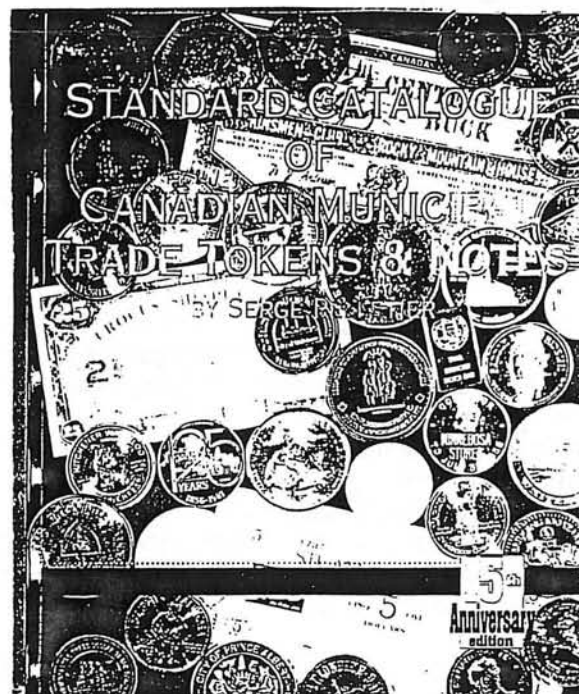

Although I wasn't at the CNA Convention, a very significant event took place for those of us who collect Canadian Municipal Trade Dollars and Notes. Serge Pelletier launched his 15th Anniversary Edition of the Standard Catalogue of Canadian Trade Tokens and Notes and made a commitment to the hobby to update the catalogue every 2 years.

For those of us who love the hobby, are we finally in the mainstream - maybe even acceptable as collectors of these Canadian issues? Without a doubt, it is a giant step forward and I for one say: "Bravo, Serge Pelletier! for the hundreds of hours of

research, for the thousands of photographs, for the tireless hours of searching for new issues and varieties from collectors in the U.S. and Canada to add to our knowledge, and lastly, for going into personal debt to make it all happen.

Since the launch, the detractors are already out in force - it's much too expensive. There are grammatical, typographical and spelling errors. The prices are wrong (as if anyone has the answer to this dilemma!). And, oh yes, there are factual errors in some of the listings - names, numbers, metals, quantities, pictures missing, and on and on.... And you know something? They are right - every last one of them! But now that we know what's wrong, let's fix it. First of all, get out and buy the catalogue to support Serge and ensure that he at least breaks even on the project. Second, find those errors and let Serge know right now so he can begin the correcting process. Third, give him information you have and he doesn't. Fourth, offer to lend him your trade dollars and notes that he hasn't photographed so he can do it now. (CONT. PAGE 74)





# EDITOR'S VIEWS

---

**GREMLINS!** No matter how hard you try, it's hard to avoid them. Seems a few of these little tricksters wreaked havoc on page 1 of the last "Ontario Numismatist". My apologies for the errors under "ONA OFFICERS" - Tom Kennedy should have appeared as Speaker cct. & Convention Coord. and K. Koch as Audio Visual....Sorry fellas - the mistake has been taken care of and hopefully, there'll be know mor!

Thanks to all who wrote with encouragement and kind words regarding my 1st issue. Letters continue to pour in from around the globe (well, you can't blame a guy for dreaming, can you?). A few that have written so far include Jim Charlton, George Rutherford and Gerry Glasser. Always nice to hear from members and clubs. Keep those letters coming.

Special thanks to Jerry Remick for his continued support of this newsletter and for his outstanding effort in promoting Canadian Numismatics in general.

I was also pleased to hear from Ray Desjardin who submitted a brief article which you'll find on page one. And in regards to this (the issuance of the municipal token catalog), my hearty congratulations to Serge Pelletier on an outstanding achievement. I encourage anyone interested in Canadian municipal tokens or notes to run out and get a copy of this book.

Tom Kostaluk, 2nd Vice President of the ONA, underwent a triple heart bypass this summer. He is now resting at home. The ONA executive and members wish Tom a full and speedy recovery!

**A CHALLENGE TO ALL ONA MEMBERS...**from yer editor. If every member could do any two of the following things in the upcoming months, the ONA and numismatics in general would greatly benefit:

- \*Sign up a new member*
- \*Write a letter to the editor - tell me what you like/dislike about the newsletter*
- \*Write an article for our newsletter*
- \*Send info. about your club for inclusion in "CLUB NEWS"*
- \*Send me your 3-4 line ad for inclusion in our classifieds (to begin next issue)*

Now...about the photo at top....bear with me for now, folks. I haven't been feeling myself lately. Maybe next issue I'll have a more recent photo for those of you who still can't figure out who I am. Until Next Month...

# MINT ERRORS & VARIETIES

By Peter Schwar

**F**inished your date sets? Looking for another collecting challenge? How about an inexpensive one? Collect mint errors and varieties! We have all seen them in catalogs and heard other collectors speak of them, but what are varieties and errors? First it must be broken down into three categories: major varieties, minor varieties, and mint errors.

Major varieties are described by the Charlton Standard Catalogue of Canadian Coins as "a coin of the same date, mint mark and denomination as another, but struck from a different set of dies, the finished coin having at least one major device added, removed or redesigned...the result of an intentional change by the mint." A minor variety is therefore the result of an unintentional alteration by the mint.

Errors are the most spectacular and oddest appearing coins. Errors are just that - mistakes. When the mint's equipment doesn't function correctly error coins are the result. These are the coins that were never meant to be released into circulation.

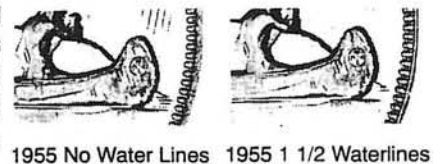

1955 No Water Lines 1955 1 1/2 Waterlines

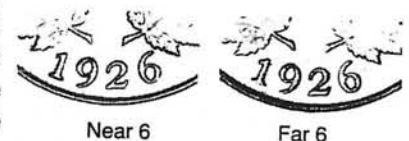

Near 6 Far 6

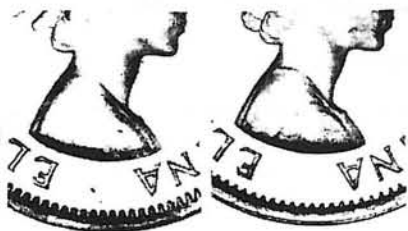

No Shoulder Fold Shoulder Fold

Still not clear what's what? Some examples of major varieties are the shoulder strap (fold) and no shoulder strap coins of 1953 to 1955. Both the SS and NSS varieties can be found on all denominations of 1953 Canadian coins and the 1 cent coins of 1954 and '55. The No shoulder strap was the first obverse variety and did not strike up well on the coins. The mint redesigned the obverse so that it would strike up a sharper, clearer coin. This is considered a major variety because the mint made the change in the obverses. Another example would be the four or more type of 1965 1 cent and silver dollar coins. Each denomination has examples of varieties made up

from a combination of distinctly different obverses and reverses, thus allowing the possibility of four or more varieties of the same denomination and date.

An example of a minor variety would be the 1950 50 cent piece. Here two examples can be found, both distinguishable to the naked eye. In one case there are lines to be seen in the 0 of 1950. This is part of the regular design.

The other variety has no lines in the 0. This was a result of a mint worker over-polishing the striking die, causing the design to be worn down, and removing the lines in the 0. The polishing of dies is part of the preparation given before coins are struck, and not an intentional alteration of the coin's design. Another example of a minor variety are the four types of 1859 one cent coins (many more varieties exist but are not widely known). Although all four are sought after by collectors of regular coinage and command high premiums, they are nonetheless minor varieties. The "9" over "8", regular "9" and two examples of double punched 9's are the result of mint workers designing the working dies the best they could with the equipment available. Such a variety could never be found in our coins of the past seventy years.



1965 Obverse

Errors are mistakes made with the machinery. The number of different errors that can be created are proportional to the number of different things that can go wrong to the machinery that produces our coins. They include blank coins, clips off the sides, coins struck off center, laminated planchets and wrong-metal coins, to name a few.

Errors happen quite frequently, but what makes them so scarce is our mint's stringent examination system of each and every coin by a computer.

Can errors be varieties? Yes, but only a minor variety. Errors are considered varieties when enough collectors deem them to be. For example, the 5 cent 1964 extra water line is in demand with collectors but

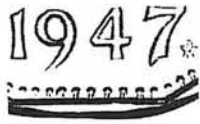

1947 Maple Leaf

it was caused by a crack in one of the striking dies. The same can be said about the 1947 dot 5 cent.

Die clash marks happen when the two working dies strike each other without a planchet (coin) in between them. A small part of one die's design will be imprinted on the other die, and vice-versa. Die clash marks are collected, but usually only after a dealer has given them a cute name such as "hanging 3" or "extra acorn". Such a name gives the impression that it is a regular mint coin (designed that way). However, these names help the novice in locating the variety and then they are dropped when the

collector learns more about his or her coins and calls them by what they are.

Pitting of dies, die cracks and die clash marks are examples of minor varieties and are sometimes collected with regular coinage.

Major errors are usually collected by type and never collected by the purist. Such examples would include capped die strikes, incuse strikes, off center coins, wrong metal, double struck coins, or even a double denomination (one denomination struck on an already struck coin). Major errors are scarce, often rare and sometimes unique.

Most dealers don't concentrate on varieties that aren't recognized by the cataloguers of Canadian coins. Therefore, with a little money, some study and a lot of looking, a collector can complete a date set of die clash marks of 1 cent or 5 cent. They can even be found in your pocket change! Should you be very interested and willing to part with more of your paycheque, there are dealer who specialize only in errors. Here you can find the exotic coins that will always make an excellent conversation piece among your collecting friends.

But as with regular coin collecting, get your education first before making a purchase and don't jump at the chance to buy each and every error or variety that comes up for sale. Collect only what interests you and remember, there are no limits.

Although no current Canadian catalogue exists for errors or varieties, it is hoped that someone will come out with one soon.



Broad Leaves



1969 Small Date

1969 Large Date

## TOKEN CATALOGUE

**CONT. FROM PAGE ONE...**After all folks, we're in this together and isn't this the fun of the hobby - participating and contributing? In the meantime, let's give Serge the credit he is due and let him know it - drop him an encouraging line with your information.



Let's be thankful we now have an incredible base of knowledge in one place that we can build from and reach out to new collectors all over Canada and the world. I personally have over 700 contacts built on this hobby and they are some of my best friends, yet I haven't even met most of them. The reason they are important to me is that we share a common interest called Canadian Trade Dollars and Notes. I for one, cherish that connection. They are the most friendly, knowledgeable and trustworthy individuals I have ever known. They're just as close to me as the many friends I have made through the City of Ottawa Coin Club.

I dedicate these few thoughts to my numismatic friend, Frank F., who has often said..."stop talking and start writing." Frank, you may be sorry - I've got lots to say and I like this writing idea.

# ONTARIO COIN CLUBS

---

*NOTE: I would like "Ontario Coin Clubs" to be a semi-regular feature of the Ontario Numismatist. If your club would like to be featured here, send me information about how the club was started; who was involved, what you do at your meetings, your logo and so forth. You may write it up yourself, or I could write it for you...as long as all pertinent details are included. Also, If your club has issued a medal, token or other numismatic item, include details (mintage figures, photocopy, compositions, reason for issue etc...).*

## THE WATERLOO COIN SOCIETY

The Waterloo Coin Society was founded in 1959, thanks to the efforts, to a large degree, of Bill English. Bill was the club's first president when the club met initially at the Waterloo Recreation Center.

By 1960, the club had changed its meeting location to the Waterloo Public Library, and under the leadership of then President Ed Stahley, adopted a club emblem.

The idea for the emblem was discussed early on in the year and it was decided that designs could be submitted by members only. A gold sovereign was offered as a prize for the best basic design submitted. Over thirty sketches were entered.

Les Marks' design, with some modifications, was eventually chosen and is still in use today. A maple leaf, with a hand grasping a coin is featured on the logo. It is symbolic of Canada and the Waterloo Coin Society, in particular.

The design was first used by the club on a medal, struck in 1961. Medals were also struck in later years, each featuring the logo on the obverse and a design of significance to the Waterloo area on the reverse. They measure 29 millimeters in diameter and were struck in a variety of metals including Bronze, silver and gold.

In 1962, the WCS hosted the founding convention of the ONA, which took place on March 24th and 25th. And in later years, they'd play host

again, the last time being in 1990.

During the 1970's and until 1985, the WCS continued to hold their club meetings at the Waterloo Public Library, with emphasis being on education, and entertainment.

Part way through 1985, the club was forced to change meeting locations once again, this time relocating to the Rink In The Park on Seagram Drive in Waterloo. They still remain here today.

Meetings are held at 8pm on the third Wednesday of the month, 12 times per year. Generally, a brief business meeting is held, followed by a 30-40 lot auction, educational display and/or talk and occasionally, a slide presentation.

Members are kept up-to-date on club events by a monthly bulletin, edited by Mike Hollingshead.

The current president is John McIntyre, who replaced the outgoing president, Don Robb. Bruce Raszmann holds the positions of Treasurer and membership coordinator.

Directors include John Hedges, Rosemary Hedges, Peter Kuchma, Robb McPherson, Earl Sheriff and Joe DeSousa.

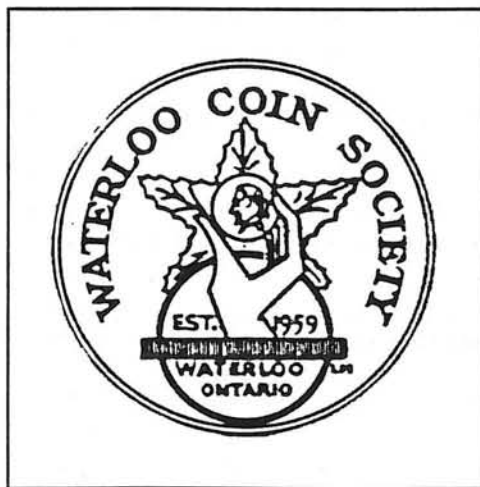

*EDITOR'S NOTE: I'm looking for information about WCS medals if someone out there can help me...in particular, info. regarding mintage figures (I also am short a few for my personal collection for those of you who might have some to spare). ★*

---

# JERRY'S CORNER

## CANADIAN MUNICIPAL TRADE TOKENS & NOTES CATALOGUED

The "STANDARD CATALOGUE OF CANADIAN MUNICIPAL TOKENS & NOTES" by Serge Pelletier was released on July 22, 1993 at the Canadian Numismatic Association Convention in Moncton, New Brunswick. It is available postpaid at \$38.50 Canadian for Canadian residents and \$35.00 U.S. for U.S. residents from The Saint Eligius Press, P.O. Box 103, Sainte Julie, Que., J3E 1X5.



*Jerry Remick*



The 432 page book is printed on 7 3/4" X 9 1/2" pages and bound with

a colorful plastic coated cardboard cover illustrating Canadian municipal tokens and notes. The book contains over 2100 photographs, including 100 enlarged photos showing varieties - all taken by Serge Pelletier. 2500 copies were printed by Serge's new publishing company, The Saint Eligius Press.

The first section covers Canadian municipal trade tokens (formerly known in Canada as trade dollars) and the second section covers municipal notes.

Trade tokens are classified by the municipality in which they were issued. The municipalities are listed alphabetically under the province or territory in which they are situated.

Brief background information on the municipality and events or things commemorated on the municipality's tokens are given for each issuing city or town. This is followed by general information on each issue of trade token in the municipality and includes the following data: issuing agency, designer, mint, diameter, edge, composition and weight for each metal if more than one metal was issued. A clear, actual size photograph of both sides of each token is then given and under the photo, Serge's catalogue number and a brief description of what is pictured on both sides. Lastly, there is a table for the tokens of each issuer for each year and each metal giving the following data: an empty square to be checked off by the collector if the piece is in his/her collection, Serge's catalogue number, the metal, mintage and a valuation.

Enlarged photographs of a portion of a token shows major die varieties.

Municipal trade notes are catalogued in a similar fashion to the tokens. A reduced size photograph of only the obverse side is shown.

A 13 page bilingual introduction explains municipal trade tokens and the hobby of collecting them.

An index of issuing municipalities, listed alphabetically by province with the catalogue number for each municipality, is near the end of the book, followed by an alphabetical index of all municipalities covered in the catalogue, their province and the page(s) on which their tokens or notes are described.

The catalogue is the result of very long and detailed research on the part of Serge Pelletier, who got the hobby of collecting Canadian municipal trade tokens started for the public in 1980 with the publication of his first check-list on the subject. This, in turn, has revitalized interest, even by some Canadians, in collecting United States municipal currency and the

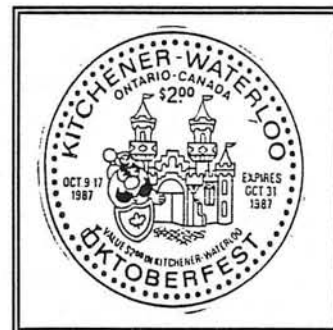

publication by a Canadian of the only recent checklist on the subject.

## COLLECTING PREPAID PAY TELEPHONE CARDS - A FAST GROWING AND POPULAR HOBBY

Collecting prepaid pay telephone cards is a new and fast growing hobby in the numismatic field. The cards, which have a specified value on them, can be used in public pay phones instead of coins. As an example, New York Telephone has issued prepaid pay telephone cards with a number of colorful pictures on them having a face value of \$5.25 and a sale value of \$5.00. The card is inserted in the pay phone. When the call is completed the amount is subtracted from the face value of the card on a magnetic tape implanted in the card. AmeriVox is selling a card for \$20.00, renewable with Visa or MasterCard.

Collecting prepaid pay telephone cards is already very popular with some numismatists and numismatic dealers in Europe, Australia and Asia, and is just now gaining a foothold in the U.S. The cards are being sold by a number of European dealers and in the U.S. sales are beginning at some coin shows.

The cards are colorful, generally having a scene from the city or country issuing them on one side and instructions on how to use them on the other side. They are the size of the average credit card and are made of plastic or plastic coated cardboard.

A number of 1993 issued cards have attractive and popular designs to entice collectors. Magic Johnson, with a basketball between his two hands ready to shoot, is depicted in a British Telecom card. New York Telephone Company issued a 4 card set of prepaid pay telephone cards featuring Ellis Island, which when placed end to end horizontally, pictures a panoramic view of the harbor during immigration at the turn of the century.

GTE Hawaii Telephone Company has issued a number of very attractive cards with scenes of the Hawaii Islands including a windsurfer riding the waves and a hilly shoreline with a rainbow. American Telephone & Telegraph Company issued a card to mark the 1993 World University Games held at Buffalo, N.Y. showing rowing, soccer players, and volleyball, as well as an older card showing part of the New York city skyline at dusk. The Swiss Alps are featured on a card from Switzerland and China has issued a number of cards showing buildings and sights in



China.

An 18 page price list of prepaid telephone cards for sale has been issued by foreign banknote dealer Steve Eyer, P.O. Box 321, Mount Zion, Illinois, 62549 (telephone 217-864-4321). His current 4th price list of phone cards contains both new and used cards for sale from 92 countries. At least 1/3 of the cards listed are available at from \$2.00 to \$5.00 each.

During the summer of 1993, a new prepaid pay telephone card magazine was first published. Called Premier Telecard, a single copy is \$9.00 postpaid and a subscription for 6 monthly issues is \$39.00 postpaid from Premier Telecard, P.O. Box 3451, San Luis Obispo, CA 93403 (telephone 805-542-9346).

An older magazine, "International Telephone Cards", brings collectors news on telephone cards which so far have been issued for more than 150 countries with over 200 telephone companies issuing them.

Classified advertising from collectors of many countries wanting to swap cards allows collectors to obtain cards for postal costs. New card issues are well covered. Issues 7 through 12 will be sent as they are issued at 20 pounds for the 6 issues from International Telephone Cards, P.O. Box 777, Colchester, CP3 3LQ, United Kingdom. Back issues 1 through 6 are available at 20 pounds. A single copy is available at 4 pounds. The firm has published a catalogue on World Telephone Cards. Visa, American Express and MasterCard are accepted.



Early in 1993, the first catalogue on U.S. prepaid pay telephone cards was issued, containing listings of more than 400 different U.S. cards. "1993 U.S. Telephone Card Catalogue" is available at \$5.00 U.S. postpaid from the author Lin Overhold, P.O. Box 8481, Medeira Beach, Florida, 33738. Over 100 cards are illustrated.

Some issues of phone cards are relatively small and demand for them, especially in Germany where the hobby of collecting them is very strong, has pushed prices into the hundreds of dollars.

Most cards are not dated so classifying and cataloguing them will be a problem.

What does the future hold for prepaid pay telephone cards. First, holograms will begin to appear on cards to insure there is not counterfeiting. Pay phones accepting coins will become fewer, replaced by those accepting cards, as it avoids maintenance and theft of coins. Definitely more attractive cards geared to collectors will be on the scene featuring famous people in all walks of life, (especially sports), buildings, commemorating events and scenes of the issuing municipality or country.

Telephone cards containing a variety of advertisements will be issued as the advertiser pays the phone company for the advertising on the card. The hobby will definitely grow in North America as material becomes available and the hobby gets more publicity. One has only to look at its popularity in Europe.

In some cases, prepaid pay telephone cards will become part of multi-use debit cards which can be used for parking meters, pay laundries, vending machines, small purchases, gasoline etc., in addition to pay telephones.

Collecting prepaid telephone cards is a new hobby that offers a wide variety of material from just about all countries at prices most collectors can afford. The hobby will most certainly grow in the U.S. and the phone cards will become a more common sight at coin conventions and coin shows.

I would like to thank Steve Eyer for the information he provided me with for some of this article and for the telephone cards he loaned me to illustrate this article.

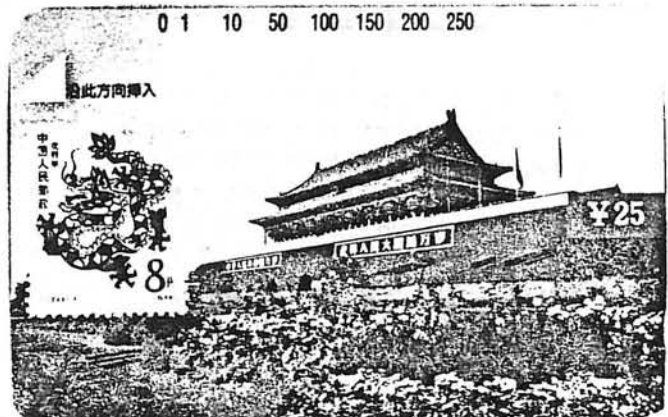
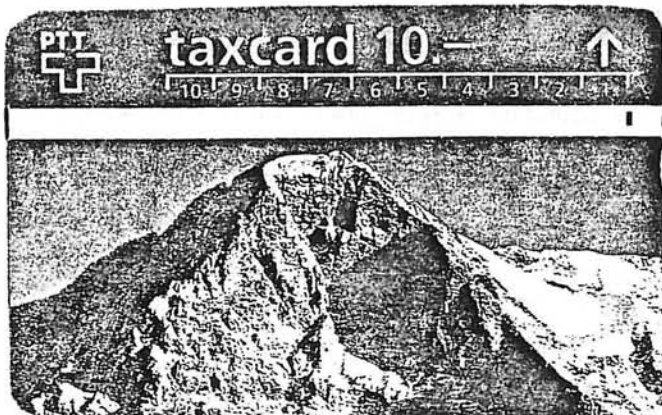

# COMPUTERS & NUMISMATICS

By Jeff Fournier (PART I)

**I**t is almost impossible to imagine what the world would be like without computers. Virtually every aspect of our lives has been touched in some way by their amazing powers - the banking we do, our entertainment, our jobs and now, more recently, our hobbies.

Yes, even the hobbies which fill our leisure hours have changed since the introduction of the computer (or more accurately, the personal computer) and will continue to change as more and more collectors take advantage of their capabilities.

It has only been a short time - just over a decade - since the home based computer came into prominence and now, many coin collectors are finding that these powerful machines can greatly aid them in the many tasks associated with their hobby.

Over the next several editions of the "Ontario Numismatist, we will explore the fascinating world of computers and how the average collector can benefit from their use.



## COMPUTERS: AN INTRODUCTION

It's not my intention to give a detailed explanation of the internal workings of a computer. The objective is to provide a little background information to aid the average collector in using a computer for his/her hobby. An understanding of the distinction made between hardware and software should serve as a basis for the beginning computer user. A more detailed explanation can be found in most magazines devoted to the subject.



## HARDWARE

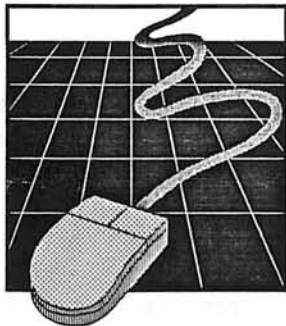

Hardware refers to the actual computer and its parts: the keyboard, used for entering data (very similar to a typewriter keyboard); the monitor, for displaying the information typed; the disk drives/hard drive, used for reading and storing information (the electronic equivalent of a file cabinet only able to hold much more data); the CPU or central processing unit (the heart of the system) made up of a power supply, integrated circuit boards and assorted other electronic equipment and finally a variety of optional items (not necessary for the computer's operation) including a printer, modem, scanner and so forth.

## SOFTWARE

The software is the coded information needed to "run" the computer. Everybody is familiar with the term "programming". But this is something that very few computer users will ever have to worry about since software, which can be purchased from any computer dealer, is in essence, a ready-made program. These "software programs" can be used by anybody, even those who have very little knowledge about the actual internal workings of a computer.

Software programs are encoded on a "floppy disk" - a storage device which can be loosely compared to a tape cassette. To use the program, simply insert the

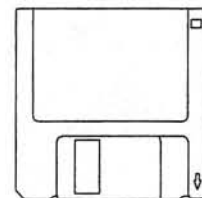

disk into your computer's disk drive and follow the instructions in the manual provided.

Many programs are now available for the coin collector which help keep an inventory of a collection, give up-to-date pricing information and even permit the printing of itemized lists that include the total retail value of a collection, total price paid, average price paid and so on.

Some software is generic in that it can be used for a variety of purposes, unlike the example given above. There are really only several different types of programs available, although each type has many, sometimes hundreds, of versions marketed by a variety of companies. The more popular ones are database programs, word processing programs, spreadsheet programs, desktop publishing programs and graphic/paint programs.

## DATABASE PROGRAMS

A database program in essence, is an information manager, ideally suited to categorizing large (or small) amounts of information. The most popular of this genre is probably DataBase III and IV although there are many less expensive versions available which should be adequate for most collectors' needs.

Database programs allow the user to take information and neatly arrange and re-arrange it. For example, a coin collector may wish to catalogue his/her collection of foreign coins. By setting up the database program to suit his/her own needs and then entering the data about the coins into the computer, it is possible to sort the items in the list by date, country, composition or what have you. When a printed copy of coins from a particular country is desired, a few simple keystrokes will yield the desired results - an alphabetical listing, for example.



## WORDPROCESSING PROGRAMS



Wordprocessing programs are designed for writing assignments and make the necessity for rough drafts obsolete. With this type of program, letters, articles, even entire books can be written with ease. If a mistake is made, it can be corrected before the written piece is printed, thus eliminating correcting fluids and ribbons. Spelling mistakes can be avoided by using electronic spellcheckers incorporated into many wordprocessing programs. Writer's block can be eliminated by taking advantage of the built in Thesaurus's available. Think how many hours you will save by using a wordprocessing program to correspond with fellow numismatists, or while writing for your favorite coin publication! "Microsoft Word" and "Wordperfect" are two of the many wordprocessing programs available.

## SPREADSHEET PROGRAMS



A spreadsheet program is one designed specifically for mathematical calculations, graphing, statistical data and accounting. One of the most popular program of this type is Lotus 123.

Spreadsheet programs can be especially helpful for maintaining financial records, which should come in handy for coin dealers and anyone else interested in keeping track of this type of data.

## GRAPHIC/PAINT PROGRAMS

For those who lack artistic abilities, graphic/paint programs can be a real life saver. These software programs simplify the process of drawing and creating captivating artwork. As well, there are a host of ready-made "graphic" pictures available on floppy disks. These can come in quite handy for producing promotional brochures, flyers and posters for your club meetings and shows. Truly professional results can be attained with a minimal amount of expenditure if programs such as Printmaster, Coral Draw and Microsoft Paintbrush are used to this end.

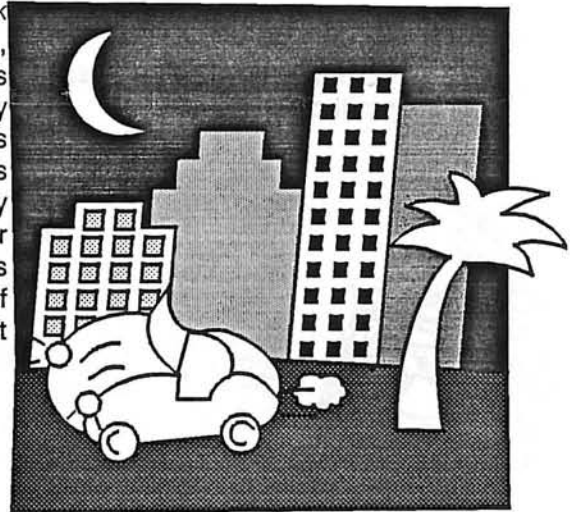

## DESKTOP PUBLISHING

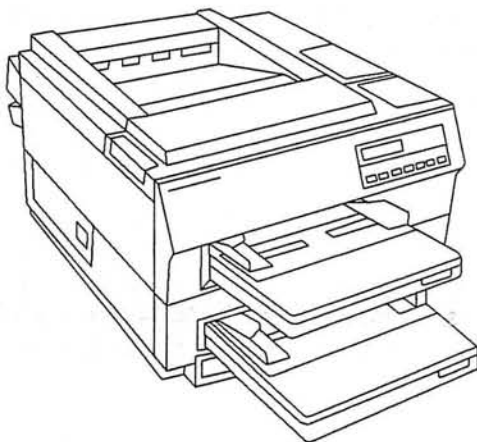

Last but not least, comes the desktop publishing software. These programs are quite new, even to the computer field, and combine wordprocessing with computer graphics. Programs such as these can be likened to having a print shop in your own home.

Desktop publishing technology is now used by many businesses, private individuals and organizations to simplify the production of their publications.

Inexpensive programs such as First Publisher will allow you to produce a top-notch newsletter for your club. Or perhaps you might want to design your own numismatic catalogue. With

desktop publishing software and a personal computer, the sky's the limit.

### COMING UP IN FUTURE EDITIONS OF THE ONTARIO NUMISMATIST:



- \*Using your computer to catalog your collection*
- \*Computer's can aid your club*
- \*Numismatic research with your computer*
- \*and much much more*



# NEW ISSUES

The Royal Canadian Mint has announced the issuance of two small denomination maple leaf coins. Both have a face value of \$1 and are 1/20th of an ounce. The first, a gold piece, is .9999 fine and joins four other gold maple leaf coins which the RCM already produces: the 1/10th, 1/4, 1/2 and 1 ounce coins.

The second coin is composed of platinum and has a fineness of .9995.

The RCM plans to issue more bullion pieces in the future, and hopes to attract buyers interested in numismatic jewelry, or smaller scale bullion products.



14 Super Electra. All RCM issues are available from coin dealers or directly from the Mint. Call 1-800-268-6468 to place your order at the Mint.

The 1993 version of the \$200 gold coin features an RCMP officer and horse in the foreground and three children. The 22kt gold coin was unveiled at the Royal Canadian Mint reception which took place at the Canadian Numismatic Association convention. The Coin Retail for \$389.65.

The seventh and eighth coins in the RCM's 10 - coin series celebrating the first 50 years of powered flight in Canada were released in May. A maximum of 50,000 of each coin will be struck. The two coins salute the Fairchild 71C and the Lockheed



## BANK OF CANADA RELEASES NEW \$20 BILL

A new \$20 note has been released, featuring an optical security device, designed to foil counterfeiters. The note is the smallest denomination to be issued with the device on it.

This is the last in a series of notes with a bird design to be released. As a point of interest, the \$20 bill is now the most widely used and circulated note among the Canadian series. This is probably because of the popularity of automatic teller machines which distribute these notes almost exclusively.

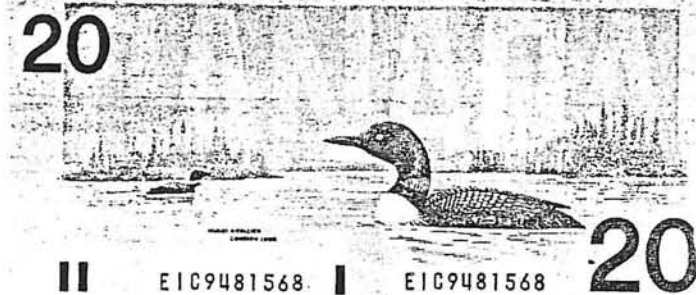

# SHOW & BOURSE

---



## **SEPTEMBER 12 - WOODSTOCK COIN CLUB 4TH ANNUAL COIN SHOW**

U.A.W. Hall, Beale St., Woodstock. Info: Woodstock Coin Club, 549 Grace St., Woodstock, Ont., N4S 4N7. Hours 9 a.m. to 4 p.m.

## **SEPTEMBER 18 - ST. CATHERINES COIN CLUB ANNUAL COIN SHOW**

Russell Ave. Community Centre, 108 Russell Ave., St. Catherines. Info: St. Catherines Coin Club, P.O. box 1492, St. Catherines, Ont., L2R 7J9.

## **SEPT 19 - LONDON NUMISMATIC SOCIETY SHOW**

Ramada Inn, Wellington Road at 401. Info: L.N.S., 543 Kininvie Dr., London, Ont., N6G 1P1.

## **SEPTEMBER 24-26 - INTERNATIONAL COLLECTORS FAIR SHOW**

Coins, stamps, postcards, medals, sportscards, sports memorabilia, paper money - Skylon Tower, Niagara Falls. Hours: Sept.24 from 1 p.m. to 9 p.m.; Sept.25 from 10 a.m. to 6 p.m.; Sept.26 from 10 a.m. to 5 p.m. Info: call (416)646-7744 or fax (416)646-0995.

## **SEPTEMBER 25 - SCARBOROUGH COIN CLUB MALL DISPLAY**

Coin display and information session at the Cederbrae Mall from 9:30 a.m. to 4 p.m. Info: Scarborough Coin Club, P.O. box 465, West Hill, Ont., M1C 2P0.

## **OCTOBER 2 - HAMILTON COIN CLUB SEMI-ANNUAL COIN SHOW**

Royal Can. Legion, Branch 58, 1180 Barton St., E., upstairs, Hamilton, Ont. Hours: 9 a.m. to 4 p.m. Admission free.

## **OCTOBER 2 - NORTH YORK COIN CLUB ANNUAL SHOW**

10 a.m. to 5 p.m. Edithvale Community Centre, 7 Edithvale Dr., North York. Free Admission. Info: North York Coin Club, P.O. box 58508, Cnr. Plaza P.O. 197 Sheppard Ave. E., North York, Ont., M2N 6R7.

## **OCTOBER 3 - SARNIA COIN CLUB SHOW**

Canterbury Inn, 1485 London Rd., Sarnia. Hours: 10 a.m. to 4 p.m. Free Admission. Info: Carl Williamson - (519)337-9191.

## **OCTOBER 9 - OSHAWA & DISTRICT COIN CLUB COIN, TOKEN AND PAPER MONEY SHOW**

To be held at the Pickering Town Center from 10 a.m. to 5 p.m. For info. call (416)728-1352 (After October 4 dial area code 905) or write to the Oshawa & District Coin Club, P.O. Box 212, Oshawa, Ont., L1H 7L1.

## **OCTOBER 31 - STRATFORD COIN CLUB ANNUAL COIN SHOW**

Stratford Kiwanis Centre, Lakeside Dr., Stratford. Info: Stratford Coin Club, Box 21031, Stratford, Ont., N5A 7V4.

## **NOVEMBER 7 - TILLSONBURG COIN CLUB ANNUAL COIN & HOBBY SHOW**

Mount Elgin Community Centre, 5 mile south of 401 and 5 mile north of Tillsonburg on hwy. 19 - exit south off 401 on hwy. 19, Ingersoll-Tillsonburg exit. Info: W. Baxter, 46 Queen St., Tillsonburg, Ont. N4G 3G9.

## **NOVEMBER 14 - WINDSOR COIN CLUB FALL SHOW**

Knights of Columbus Mall, 1140 Goyeau St. Hours: 9:30 a.m. to 5 p.m. Info: Ron Binder 9519254-6855 or 2279 Hall Ave., Windsor, N8W 2L8.

## **NOVEMBER 27 - WATERLOO COIN SOCIETY COIN SHOW**

The Rink in the Park, Seagram Dr., Waterloo. Hours 10 a.m. to 5 p.m. Free Admission and Free Parking. Info: Don Robb, P.O. box 22062, Westmount Postal Outlet, Waterloo, Ont., N2L 6J7.

## **APRIL 22-24/94 - O.N.A. CONVENTION - HOSTED BY THE NORTH YORK COIN CLUB**

Howard Johnson Plaza Hotel (Formerly Skyline Triumph Hotel), 2737 Keele St. (at Wilson Ave.), North York, Ont. For info contact: The North York Coin Club, P.O. Box 58508, Corner Plaza P.O., 197 Sheppard Ave. East, North York, Ont., M2N 6R7

## **SECOND SUNDAY EACH MONTH - OTTAWA COIN, STAMP, DEALERS ASSOC. SHOW**

Nepean Sportsplex, Woodsroffe Ave., 10 a.m. to 4 p.m. Info: Allan Davis, P.O. box 397, Carp, Ont., D0A 1L0.

\*Send info. regarding shows, displays, special club events to: **JEFF FOURNIER, P.O. BOX 2111, STN. "A", SUDBURY, ONT., P3A 4R8.** Next deadline for the Nov./Dec. issue of the "Ontario Numismatist" is Nov. 1/93\*

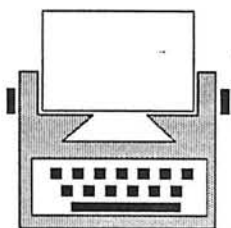

# **CLUB NEWS**



### **HURONIA NUMISMATIC ASSOCIATION**

28 were present at the July meeting, which featured a film entitled "Coins For Canada & The World", produced by the RCM. The meeting also featured, not only coins, but Dionne Quints collectors books and a laptop computer used with a radio to talk to Toronto.

The August meeting newsletter mentioned the recent honor bestowed upon President Ken Prophet - the recipient of the J.Douglas Ferguson Award.

The September 16th meeting will feature a roast beef dinner.

### **NICKEL BELT COIN CLUB**

The club will meet on Sept. 19th for business, 65 lot auction and a display on Sudbury Numismatics.

The summer months were busy, even though no meetings were held, as the club manned a coin display at the Capreol 75th anniversary festivities. Coin displays were also featured at the New Sudbury Mall Library, South-branch library and Copper Cliff Library.

### **NORTH YORK COIN CLUB**

The club's 375th meeting was held on June 22 with 37 in attendance (a club record). A numismatic quiz was led by Paul Johnson, followed by an auction.

The newsletter featured a notice for the Coin Show which the club will host on Oct. 2.

### **CHAMPLAIN COIN CLUB**

the June 3rd meeting featured a ham and turkey buffet supper in honor of the club's 31st anniversary. The first meeting of the fall/winter season was held on Sept.2.

## WATERLOO COIN SOCIETY

At the July meeting, members spoke about the various collections they were working on. The August meeting was to feature editor Mike Hollingshead speaking on "Paper Money Replacement Notes". A 40 lot auction was also scheduled. The club's monthly newsletter contained an interesting article on Canadian "shinplasters".

**WE'D LOVE TO HEAR FROM YOUR CLUB!** *Are you currently sending your club newsletter or a brief outline about what's going on at your club to the ONA editor. If not, put us on your mailing list. Even if you don't have a newsletter, let us know what's going on in your club. How's the hobby scene in your area? Write to the ONA Editor Jeff Fournier, P.O. Box 2111 Stn. "A", Sudbury, Ont., P3A 4R8.*

---

# NEW MEMBERS

The applications for membership which appeared in the July/August issue of the Ontario Numismatist have been accepted.

1353 Bill Baxter, Tillsonburg, Ontario  
1354 John Krystia, Sudbury, Ontario  
1355 Earl MacLean, Oshawa, Ontario

The following application for membership has been received. If no written objection to this application is received, acceptance will appear in the next issue of the Ontario Numismatist.

C103 London Numismatic Society, c/o James A. Finch - Pres., London, Ont., N5Y 3A5

**HAVE YOU RECRUITED A NEW MEMBER YET THIS YEAR? DO YOUR PART TO HELP THE ONA GROW IN NUMBERS. SPREAD THE WORD ABOUT OUR ORGANIZATION.**

---

## INTERESTED IN U.S. COINS?

If you're interested in current year U.S. Mint sets and so forth, the U.S. Mint's mailing address is: **THE UNITED STATES MINT, PO BOX 41589, PHILADELPHIA PA, 19101-1589.** Featured here are three coins (clad half dollar, silver dollar and gold \$5 piece) issued to commemorate the 50th anniversary of WWII. Maximum mintages are 300,000 (gold), 2,000,000 (half \$) and 1,000,000 (silver \$). Each is sold separately, or available in sets - either proof or uncirculated quality.



**\*\*THOUGHT FOR THE DAY\*\***The Mint makes it first....it's up to us to make it last!

---

---

# ❖ 1994 ONA CONVENTION ❖

---

---

C/O NORTH YORK COIN CLUB, P.O. BOX 58508, CORNER PLAZA P.O., 197 SHEPPARD AVE. EAST, NORTH YORK, ONT. M2N 6R7

---

---

July 15, 1993

TO: ALL ONA MEMBER CLUBS

SUBJECT: 1994 ONA CONVENTION  
APRIL 22 - 24, 1994  
HOST: North York Coin Club

Although you will be receiving a number of news releases over the next nine months covering details on the 1994 ONA Convention, as a start, we would appreciate if you could list the following information in the "UPCOMING EVENTS" column of your club bulletin:

EVENT: 1994 ONA CONVENTION  
TIME: April 22 to 24, 1994  
LOCATION: Howard Johnson Plaza Hotel,  
(formerly Skyline Triumph Hotel)  
2737 Keele St. (at Wilson Ave.,)  
NORTH YORK, Ontario  
HOST: North York Coin Club,  
P.O. Box 58508, Corner Plaza P.O.,  
197 Sheppard Ave. East,  
NORTH YORK, Ont. M2N 6R7

We will be sending you releases from time-to-time that we hope you will distribute to your members, either at club meetings or through your club bulletin.

Thank you for your cooperation.



Sincerely,

*John*  
John Regitko,  
Publicity Chairman,  
Numismatic Publications,  
1994 ONA CONVENTION



# ONTARIO NUMISMATIST

OFFICIAL PUBLICATION OF THE ONTARIO NUMISMATIC ASSOCIATION  
ISSN 0048-1815

VOLUME 32 NOVEMBER/DECEMBER PAGE 87-93

## O.N.A. OFFICERS

### IMMEDIATE PAST PRESIDENT

G. Oblinski

### PRESIDENT

R. Zeik

### FIRST VICE PRESIDENT

H. Farrow

### SECOND VICE PRESIDENT

T. Kostaluk

### SECRETARY

Vacant

### TREASURER & MEMBERSHIP

B.H. Raszmann

### DIRECTORS

Area 1a: R. Binder

Area 1b: S. Hodge

Area 2: T. Masters

Area 3: R. Voaden

Area 4: R. Fletcher

Area 5: K. Wilmot

Area 6: E. Workman

Area 7: A. Kasman

Area 8: Vacant

Area 9: B. Uman

Area 10: R. Albert

### HEAD JUDGE

E. Workman, R.R. #2 Cannington,

On., L0E 1E0

### SPEAKER CIRCUIT &

### CONVENTION

### COORDINATOR

Tom Kennedy, 54 Trinity St.,

Stratford, On., N5A 4P4

### AUDIO VISUAL

K. Koch, 219 Southwood Dr.

Kitchener, On., N2E 2B2

### LIBRARIAN

T. Masters, 823 Van Street

London, Ont., N5Z 1M8

### EDITOR

J. Fournier, P.O. Box 2111, Stn. "A",

Sudbury, Ont., P3A 4R8

## MEMBERSHIP

REGULAR MEMBERSHIP,

\$10.00/Yr.; HUSBAND & WIFE (1

JOURNAL), \$12.00/Yr.; JUNIOR

(TO 18) \$3.00/Yr.; LIFE

MEMBERSHIP (AFTER 3 Yrs. REG.

MEMBERSHIP), \$100.00; CLUB

MEMBERSHIP, \$15.00.

Remittances to: THE ONTARIO

NUMISMATIC ASSOC., P.O.B.

40033, WATERLOO SQUARE P.O.,

75 KING ST. SOUTH, WATERLOO,

ON, N2J 4V1.

## THE CANADIAN CENT

BY JAMES E. CHARLTON



Canadian cents are an attractive, historically-interesting and inexpensive denomination to collect, thus appealing to both the young and mature collector.

The cents cover a span of one hundred and thirty five years, and the transition of Canada from a sparsely populated, undeveloped country to an industrialized, self-governing dominion of twenty-seven million people.

The large and small cents were issued during the reigns of seven British monarchs, although only six monarchs are represented on the coins. None were issued with the

portrait and legend of King Edward VIII. During his brief reign from January to December of 1936, the coinage of King George V was continued.

The large cents commenced with those of the Province of Canada with the portrait of Queen Victoria, dated 1858 and 1859. The total order of ten million pieces was far above the actual requirement and resulted in a huge surplus. Several million were inherited by the Dominion of Canada at the time of Confederation in 1867. They were issued as Dominion of Canada cents until 1876 when their own issue of large cents commenced.

In the early years, the Dominion cents were only ordered as required which resulted in there being a number of years when none were issued. The years of issue were 1876(H), 1881(H), 1882(H), 1884, 1886, 1887, 1888, and 1890(H) to 1901 in consecutive years. Yearly issues continued for the reigns of King Edward VII, 1902-1910 and King George V, 1911-1920. There are forty dates of the large cents and they are readily available from dealers in Canadian coins at modest prices. (Continued on page 92).



# PRESIDENT'S MESSAGE

The C.N.A. convention in Moncton N.B. in July was well attended and the hospitality was first class. Thanks to Geoff Bell, Wayne Gillcash and their top notch crew for a wonderful week in the Maritimes. I am pleased to see another successful convention. The big news was the Elections of office for many of the positions. As president of the O.N.A. I would like to congratulate Dr. Marvin Kay as the new C.N.A. President, Yvon Marquis as First Vice President and Jeffrey Hoare as Second Vice President. The two area directors in Ontario went to Tom Kennedy (South West), and Sean Isaacs (North East). May the next two years be prosperous.

I would also like to take this opportunity to tell you other C.N.A. news from the convention, Congratulations to Kenneth Prophet of Barrie for receiving the J. Douglas Ferguson Award for 1993. This award is the highest C.N.A. award. Congratulations to Geoff Bell for winning the Royal Canadian Mint Award, the Calgary Numismatic Society for the 1992 Louise Graham Memorial Club of the Year Award, Kenneth Prophet for becoming a Fellow of the C.N.A. and to the ONTARIO NUMISMATIC ASSOCIATION and Tom Masters for the best regional newsletter. I would like to especially thank Tom Masters for his dedication to the hobby and his editorials over the years. I know that Jeff Fournier, our new editor, has big shoes to fill, but I know he will do well.

I was also in Baltimore Md. at the American Numismatic Association annual convention with our First Vice President, Harvey Farrow. That was the largest convention I have ever seen. Over 450 dealer booths with 2000 Registered Dealers, 15,000 registered guests and five days of hot weather. We arrived with a 99 degree F. (37 C.) heat wave. I can say that it cooled to 92 F. by the time we left Sunday morning, August 1. The sites were fantastic. Two O.N.A. members received their 25 year A.N.A. membership pins, William MacDonald, (our current Award of Merit winner) and Paul Petch of Etobikoke. Congratulations once again to all who had a memorable summer.

Now that the Fall is coming and many local shows are scheduled for the next several months, I would like to see many of our members and friends at these shows. If there is anything the O.N.A. can do to be of assistance, please let me know and WE the O.N.A. will do our best to help.

As always, your President,

**RON ZELK**

Ron Zelk.





# EDITOR'S VIEWS

---

Hello...It's me again!! Hold onto your hat folks, we're in for a real numismatic journey this issue. On the front page, Jim Charlton, who needs no introduction, opens this issue with an interesting article on the Canadian cent. Later, Jerry Remick writes about a new Canadian Tire Coupon catalog, a medal issued by the Woodstock Coin Club, and some interesting numismatic Christmas ideas. I'll be continuing my series on Computers and Numismatics this issue. And there'll be the usual assortment of news items from clubs, show info. and so forth.

I always enjoy reading the various club newsletters that I receive each month, but would like to see more of them coming my way. If your club doesn't have ye editor on the mailing list, don't delay...send your most recent copy to me ASAP! (P.O. Box 2111, Stn. "A", Sudbury, Ont., P3A 4R8).

Speaking of newsletters, the wry, satirical humour of Waterloo Coin Society editor Mike Hollingshead has been ticklin' my funny bone. I also appreciated the generous compliments he threw my way in the October issue:

*"I must congratulate Jeff Fournier on the new format of the ONA Numismatist. It is obvious that Jeff has more time than I and many more editors have, as well as, greater expertise and computer hardware/software. How he does it I don't know, I only hope it lasts!....I suggest that WCS members ask Bruce Raszman for information about becoming members of the Ontario Numismatic Association. The newsletter alone is 'worth the price of admission'."*

Thanks for the plug Mike! And to satisfy your curiosity about how I find the time for this newsletter...don't forget, Mike, we Sudburians run on E.S.T. year round (Extended standard time). Yup, that's right! We get an extra 2 hours each day here (that's 26 hours, Mike). During those two extra hours a day, I'm able to get most of this newsletter completed. Of course, typing 42 words/minute helps out a little bit, too.

On to another topic - I received a letter from Ray Desjardin the other day. Ray, as some of you might know, runs a mailorder business selling municipal tokens, medallions, pins etc... and commented on the ONA's policy of not publishing new members' addresses. He commented that as a dealer, and as a collector, he would like to see these published in the future, providing, of course, that the new member agrees to this. Ray maintains that many collectors like to correspond and do a fair bit of buying/selling/trading and swapping coin stories, through the mail. I agree! But I'm really not sure what the executives' reasons are for not publishing these names (as I mentioned before, so long as it's O.K with the new member). Maybe this could be a topic at the next executive meeting.

Since you won't be hearing from me again until January '94 - MERRY CHRISTMAS! (You'll note I've donned the Santa suit for this issue - maybe next issue I'll pose au natural...!)

# COMPUTERS & NUMISMATICS

## COMPUTERS CAN AID YOUR CLUB

By Jeff Fournier (PART II)

Many coin clubs are now discovering that a computer can be beneficial to their organization. Most clubs are in constant search of new ways to cut costs, improve their newsletters and publicize their meetings and shows. In this article, we'll explore some of the many ways in which a computer can help you meet these goals and many others.

### PROFESSIONAL LOOKING NEWSLETTERS

Talk to any veteran numismatist and he's likely to tell you that one of the secrets to a successful club is to regularly publish a newsletter.

The problem which many clubs face, however, is a lack of know-how when it comes to designing and printing such a publication. This is precisely where a computer can help.

Wordprocessing software is one of the easiest types of programs to master and thus lends itself quite readily to the task of producing a top-notch newsletter.

Perhaps you have already had some experience in using wordprocessing programs. If not, you've likely heard how easily your documents can be manipulated and changed once they are inputted into a computer.

Whole sentences, paragraphs or a single word can be moved or deleted with a few keystrokes. Thus, it is a simple task to correct spelling errors or re-arrange your written thoughts on the computer screen.

Often used phrases or words can be saved onto a disk for future or repeated usage, eliminating the need for retyping. You may, as an example, wish to include the names of your executive committee on the front page of your newsletter. Instead of typing these names each time you create a new newsletter, type them once, then save them in a separate file for inclusion in future issues.

Some of the newer wordprocessing software is quite sophisticated and allows you to use different fonts (style of type), set up "newspaper column" format (two or more columns of type per page - just as in a newspaper), and include graphics (pictures and symbols).

Another type of program which can be used quite successfully even by a computer novice is desktop publishing software ("DTP" for short). This is similar to a wordprocessing program but is designed especially for the production of newsletters and so forth. I would recommend a program such as "NewsMaster" or "First Publisher" since they are quite inexpensive and easy to use.

**Oshawa & District Coin Club**  
Box 212, Oshawa, Ontario L1H 7L1

# NEWSLETTER

Volume 2 Issue 8 October 1993

## COIN SHOW

You may notice that this issue of the newsletter is being delivered a little early as our next meeting isn't until OCT 17 1993. I thought I would send the newsletter out a little early just to remind everyone of our SHOW. Remember now, our show is to be held at the Pickering Town Centre on OCT 09 1993. We have 18 dealers of which 5 of them we haven't seen before at any of our shows. There will be 24 dealer tables and 2 club tables, the club tables will be beside the Scotiabank & Toronto Dominion Bank entrances. The dealer tables will run from the Dominion Store down to the K-Mart store. If you get a chance, please try and attend our show, I'm sure if your looking for something special, you will find it here.

## Area Code Change

Just a reminder, as of Oct 05 1993 the area code (416) will be changed to (905) for all numbers surrounding Toronto. My current plan is update the Club's phone records will be to change all area code listings to 905 for all members and dealers that have a postal code starting with 'L'. Please note 'L' is used for all towns and cities surrounding Toronto. If your area code isn't changing and your Postal Code starts with 'L', please let me know!

## Next Meeting

As I mentioned the next Club meeting will be held at the Arts Resource Centre (Map on reverse) on OCT 17 1993 at 12:30 P.M. If you know anyone that may be interested in Numismatics, please bring them along, remember that everyone is welcome.

## Niagara Falls Show

I managed to take in the Niagara Falls show on the weekend of Sept. 24 - 26 1993, there was a lot of coin dealers at this show. The floor didn't seem to be very busy on Saturday when I was walking around, but the dealers seem to be doing well. This show is held in the Skyline Tower and is very noisy due to the arcade and rides that are in the basement. Bidding at the auction seems to be going very well, most of the coins were going

## Moninating Committee

As we didn't get any volunteers at our last meeting, we will need to get some volunteers at the next meeting to form our moninating committee, remember that the moninating committee only has to find people that want to run for one of the many available positions. Without volunteers we will have a hard time having elections, we should be thankful that we don't have the problems our governments do, he he

## Attendance Draw Coupon

Oshawa & District Coin Club  
Attendance Draw \* OCT 17 1993

NAME: \_\_\_\_\_  
Membership #: \_\_\_\_\_

Your EXECUTIVE for 1992 to 1993:  
President: Tom Alexander Sr. Vice President: Tom Alexander Jr. Treasurer: Bruce Watt  
Editor & Membership: Earl McLane Secretary: Nancy Alexander Librarian: Sharon McLane  
Chairman: Albert Kamman, Bob Proter, Ed Kopic, Les Sigurd, Paul Legros, David Latham, Harvey Farnon

Oshawa & Dist. Coin Club Newsletter



DTP programs are useful when you wish to create multi-column newsletters with graphics incorporated into them. Most will also allow you to create boxes, lines and sometimes, your own drawings. Used along with a dot-matrix or laser printer, a professional looking bulletin can be created within a couple of hours.

Your club newsletter could include feature articles on decimal coins, members' collecting interests or beginning a coin collection. It could also incorporate brief summaries of stories from a few of the numismatic publications which you receive. Club minutes should be a regular feature, since they allow those members who were not able to attend the meeting to keep abreast of the latest happenings. Also, you may decide to begin a classified section where members can advertise for coins they need or are willing to sell. The possibilities are endless. Use your own imagination. Start by collecting articles, and other information which you need, from various sources including other members. This information can be entered into the computer at various intervals. Experiment with different fonts and layouts. Above all, don't try to fit too much on a page as you risk overcrowding. Include graphics to draw attention to important articles or announcements such as club shows.

The beauty of using a computer for your newsletter lies in the fact that you can actually see your finished product on the computer screen before you print it up. If you are not pleased with the results, manipulate and move articles, paragraphs and graphics until the desired results are obtained. Once this has been accomplished, proof read it, save your work on a disk (you should actually do this several times during your work session) and then print it out on your printer.



One alternative to using a dot-matrix printer, which yields inferior quality documents when compared with a laser printer, might be to bring your disk with the saved newsletter to a professional desktop publishing firm. Here, they can print your newsletter on a laser printer for a few dollars. Remember, you've done all the work - the layout, typing and so forth - and all the printer has to do is print it up. Voila!! your newsletter is complete. Now you can reproduce it on a photocopier to make the required number of copies for your members.

## ADVERTISE YOUR CLUB

In a sense, your club is like a business - not that it is out to make a huge profit - but because it must be promoted constantly. Coin clubs must be kept in the public eye to ensure that all potential members are aware of its existence. What better way to do this than to create some promotional brochures and posters?

Some clubs have, in the past, put together brochures about the history of their organization, its objectives and so on. Then, they have gone off to the printers to have it typeset and printed up. The same goes for posters which perhaps were spread around town to advertise an upcoming meeting or show.

Now here's an opportunity to put your computer to work! Why not take advantage of some of the desktop publishing programs and/or graphics/paint programs to create a neat and inexpensive brochure for your club. You can also design posters featuring graphics, perhaps your club logo, and any



JOIN THE

# NICKEL BELT COIN CLUB

FOR COLLECTORS OF



COINS  
TOKENS  
MEDALS  
PAPER MONEY



MEETINGS ARE HELD ON THE 3RD SUNDAY OF EVERY MONTH (EXCEPT JULY AND AUGUST) AT 2:00 PM IN ROOM C-11 OF SUDBURY'S CIVIC SQUARE. FOR INFORMATION CALL 560-7385





NICKEL BELT COIN CLUB POSTER

pertinent information appropriate for the circumstances. Once you've completed your brochure or poster, it's simply a matter of making the required number of copies at the copy shop. This could save your club hundreds of dollars in printing costs.

Some clubs, before now, were unable to have professional looking posters and so forth because the cost was prohibitive. A computer should allow more clubs to increase their advertising output and hopefully, draw new members.

## OTHER USES



Why not keep a record of members in your club on a computer? Data base programs lend themselves to this task.

You might also want to make a listing of library books in your club library so that members are made aware of the titles available. This listing can be easily updated once the original is inputted.

Forms, forms and more forms....It seems that forms are used endlessly for most coin clubs: applications for memberships, member questionnaires, forms for club auctions and the list goes on. Why not produce these on your computer as well. The task is really quite simple by using any number of programs such as a spreadsheet (Lotus 123 with the "Always" add-in is a good example) or a DTP program to jazz the form up a little bit.



And we're not forgetting you Mr. Secretary! Those countless hours spent writing letters to other clubs or in answer to inquiries can be reduced by using a wordprocessing program.

Last, but certainly not least, the club's financial records can be easily handled - again by a spreadsheet program - and kept up to date with the computer. PART III: "CATALOGUING YOUR COLLECTION WITH A COMPUTER".



## CANADIAN CENTS (CONT. FROM PAGE 87)



The few varieties and those in above average condition will cost more, but considerably less than most other denominations of Canadian coins for the same period.

In 1920, as a matter of economy, a change was made to a small cent similar in size and composition to that of the United States. In 1982 the small cent was changed from a round to a twelve-sided piece and reduced in weight by 10.7%. In addition, a substantial saving in production cost, it was easier for the blind to identify. The small cents are yearly issues and apart from the 1922 to 1926 dates, which were released in small quantities, a date set is not difficult to assemble at affordable cost. Although not unobtainable, acquiring the early dates in new condition can present an interesting challenge. Most collectable varieties of the small cents are easily obtained and inexpensive. (Reference material from the Charlton Standard Catalog of Canadian Coins).



Shoulder Fold



1947



No Shoulder Fold

# ONTARIO COIN CLUBS

*NOTE: I would like "Ontario Coin Clubs" to be a semi-regular feature of the Ontario Numismatist. If your club would like to be featured here, send me information about how the club was started, who was involved, what you do at your meetings, your logo and so forth. You may write it up yourself, or I could write it for you...as long as all pertinent details are included. Also, if your club has issued a medal, token or other numismatic item, include details (mintage figures, photocopy, compositions, reason for issue etc...).*

## THE WOODSTOCK COIN CLUB

The Woodstock Coin Club was formed in June of 1957 by an enthusiastic group of local collectors. The first meeting was held on June 26th at the old Y.M.C.A building, now the site of Canada Trust. Many members of the London Coin Club attended and assisted in the early stages of the Woodstock Coin Club's formation.

Soon, an executive was elected and included Jack Griffin as President, Jim Walker as Vice President, Bill Allen, Secretary and Gordon Bowerman as Treasurer. Two directors - Albert White and Charles Piper - were also elected.

A small bulletin was printed for each meeting and a full slate of events were planned.

Before long, the club grew in numbers until membership reached 30.

A banquet was first held in January of 1960 with 130 registrants.

The club began striking a series of medals in 1965 which continued until 1973. Each medal contained a local theme or building, and were struck in a variety of metals including silver, bronze and nickel-silver, for most years.

In 1988, the club's medal series was re-instituted, beginning with a piece commemorating the 150th anniversary of the first recorded baseball game in Canada played at Beachville on June 4th, 1838.

Another medal, featuring a rooster was issued in 1990 followed by a piece issued in 1993 (described in more detail in Jerry Remick's column).

These later series have many varieties and present a challenge to the individual wishing to complete a collection.

By the mid-1970's, club membership began to slump, due in large part to a slump in coin collecting in general. The club ceased activities for many years until it was revived by Charles Laister.



One of the highlights for the club came in 1989 when they, along with the Ingersoll Coin Club and Tillsonburg Coin Club, hosted the annual ONA convention.

(If your club has issued a medal in the past, I would be pleased to receive information about it such as how many were struck, by whom and in what metals. Write the ONA Editor with details!)

# JERRY'S CORNER

## FREE DIE AVAILABLE FOR PERSONALIZED CHRISTMAS MEDALS



A die is available without charge for making 38 mm personalized Christmas medals in brilliant gold-plated copper and nickel-silver.

The die shows a horse pulling a sleigh with several homes in the background and trees. "1993" is below the design. "MERRY CHRISTMAS" in English, Spanish, French and Russian is around the outer part.

The die is in the possession of Pressed Metal Products, 505 Alexander St., Vancouver, B.C., V6A 1C8 (telephone 604-251-

2454). They cut the die and can make the medals. A personalized die with one's name, address and other data would run \$200. 100 medals are \$3.30 each plus postage. A smaller quantity of medals can be ordered.

Jerry Remick paid for the Christmas die. There is no charge to use it. A Christmas die has been available annually for public use, free of charge, since 1983.

A sample personal medal with the 1993 Christmas design on one side and Jerry Remick's personal logo on the other side is available in brilliant gold-plated copper or nickel-silver at \$3.25 postpaid each or 3 for \$9.95 postpaid from Jerry Remick, P.O. Box 9183, Sainte Foy, Que., G1V 4B1.



*Jerry Remick*



## 4TH EDITION OF BILODEAU'S CANADIAN TIRE COUPON CATALOG



The 4th edition of the "Guide Bilodeau" by Ovide Bilodeau, Ghislaine Memme and Jerome Fourre was released early in October postpaid at \$24.95 for members of the CCCT and \$29.90 for non-members from Jerome Fourre, P.O. Box 74, New Glasgow, Que., J0R 1J0. Please make payment to the order of Jerome Fourre.

This completely bilingual catalog on Canadian Tire Cash Bonus Coupons is bound by a deluxe

three-ring binder, permitting updating in the future without purchasing a new catalogue. The 175 catalogue is printed on 5.5" X 8.5" pages. The catalogue is divided into eight sections, each separated by a cardboard page with tab extending outward .5" from the other pages printed with the title of the section. The sections are as follows:

Introduction, Canadian Tire Gas Bar Coupons, Canadian Tire Store Coupons, Sandy McTire Coupons, Montcalm Coupons, Canadian Tire Catalogues, Miscellaneous Canadian Tire Coupons and token prices. A photo of both sides of each type of coupon is presented as well as a text with details on the issue





became a member of the cabinet of Sir Wilfred Laurier. Ken and Eleanor Ovington, members of the Woodstock Coin Club, designed the medal. Their initials are inscribed to the right of the lower part of Mr. Sutherland. Pressed Metal Products, 505 Alexander, Vancouver, B.C. cut the dies and struck the following mintages on 38 mm antiqued planchets: silver-plated copper (500), gold-plated copper (250), copper (250) and pure silver (35). The obverse and reverse sides are not rotated. The pure silver medals were sold out during the first hour of the 1993 Zorra Highland games, so a second striking was made with the obverse and reverse sides rotated 180 degrees and consisted of 68 in pure silver and 20 in copper. Specimens are available postpaid at \$8.00 each for the copper, gold-plated and silver-plated specimens and \$36.00 for the pure silver specimens from Mr. Rollie Rutherford, P.O. Box 89, Embro, Ont., N0J 1J0 (telephone 519-475-4171). This is one of the best designed club medals I have seen in a long time. The medal shows good detail and good relief.



## NEW ISSUES

The Royal Canadian Mint has issued its 4th platinum proof set in a five-year program that started in 1990. The three previous sets paid tribute to the polar bear (1990), the snowy owl (1991) and the cougar (1992). The 1993 set is a tribute to the Arctic fox, and was designed by Montreal artist Claudio D'Angelo. Mintage will be limited to 3500 sets and will sell for \$1955 Canadian. The set is available from the Royal Bank coin dealers or directly from the RCM, P.O. Box 476, Station A, Ottawa, K1N 9H3 or through the RCM's toll-free phone line: 1-800-267-1871.

The coins come in four denominations: \$30, \$75, \$150 and \$300, and are all .9995% pure.



# SHOW & BOURSE

---



## **NOVEMBER 7 - TILLSONBURG COIN CLUB ANNUAL COIN & HOBBY SHOW**

Mount Elgin Community Centre, 5 mile south of 401 and 5 mile north of Tillsonburg on hwy. 19 - exit south off 401 on hwy. 19, Ingersoll-Tillsonburg exit. Info: W. Baxter, 46 Queen St., Tillsonburg, Ont. N4G 3G9. 9 a.m. - 5 p.m.

## **NOVEMBER 14 - WINDSOR COIN CLUB FALL SHOW**

Knights of Columbus Mall, 1140 Goyeau St. Hours: 9:30 a.m. to 5 p.m. Info: Ron Binder 9519254-6855 or 2279 Hall Ave., Windsor, N8W 2L8.

## **NOVEMBER 27 - WATERLOO COIN SOCIETY COIN SHOW**

The Rink in the Park, Seagram Dr., Waterloo. Hours 10 a.m. to 5 p.m. Free Admission and Free Parking. Info: Don Robb, P.O. box 22062, Westmount Postal Outlet, Waterloo, Ont., N2L 6J7.

## **APRIL 22-24/94 - O.N.A. CONVENTION - HOSTED BY THE NORTH YORK COIN CLUB**

Holiday Inn, North York, Ont. For info contact: The North York Coin Club, P.O. Box 58508, Corner Plaza P.O., 197 Sheppard Ave. East, North York, Ont., M2N 6R7 (\*Note the change in location\*, as per info. received from Bruce Raszman - more details next issue).

## **SECOND SUNDAY EACH MONTH - OTTAWA COIN, STAMP, DEALERS ASSOC. SHOW**

Nepean Sportsplex, Woodsroffe Ave., 10 a.m. to 4 p.m. Info: Allan Davis, P.O. box 397, Carp, Ont., D0A 1L0.

\*Send info. regarding shows, displays, special club events to: JEFF FOURNIER, P.O. BOX 2111, STN. "A", SUDBURY, ONT., P3A 4R8. Next deadline for the Jan./Feb. issue of the "Ontario Numismatist" is Jan. 1/93\*



# CLUB NEWS



## **CHAMPLAIN COIN CLUB**

11 members turned out for the October meeting, presided over by vice-president Scott. Plans were made for the banquet to be held Nov. 4th and featuring a hot turkey dinner. Santa will be paying a visit, and a film will be shown.

## **HURONIA NUMISMATIC ASSOCIATION**

The club meeting featured a roast beef dinner with Master of Ceremonies being John Regitko. Coming events include elections and donation auction in November and a Christmas party the 3rd Thursday in December.

## INGERSOLL COIN CLUB

Editor Tom Masters commented in the October bulletin about the number of Fall coin shows and wondered if there were too many at this time. "It seems to me that if you are planning a show, there are more dates available in the spring", he commented.

It was noted at the September meeting that the November banquet was cancelled, to be replaced by a special lunch at the December 20th banquet.

The October meeting was to feature "Canada's Commemorative Dollars 1935-1967" and a "History of the Ingersoll Coin Club".

## LAKESHORE COIN CLUB

At the September meeting of the Lakeshore Coin Club Pat Campbell talked about all the numismatic references he found in all the "Sherlock Holmes" mysteries. He concentrated on the coins which were almost all from Queen Victoria. He covered each denomination from a farthing to a guinea and related where each piece was used and in which story. He showed a complete collection (type) of Victoria coins and also brought 2 books on Sherlock Holmes, one containing all of the stories and the other showing book plates and drawings. Over 30 members attended the 1st meeting of the 1993 - 1994 season.

## NICKEL BELT COIN CLUB

22 members were present at the October meeting. The topic for the afternoon was "coin storage and protection" - a brief talk and display by the President, Jeff Fournier, covering various methods of storing coins. A 65 lot auction was held and approx. 85% of all lots sold. Members were reminded that the donation auction would be held at the January meeting.

## NORTH YORK COIN CLUB

The club's Oct. 2 show was a huge success with dealers having a "killer of a day" in sales. The club came out with a profit. The Sept. meeting featured John Regitko speaking on coin designer Don Patterson. Paul Johnson talked about his interest in collecting trains on medals or coins. Paul Petch presented info. on the Preservation of books in the home and Norm Belsten talked about collecting wooden nickels.

At the Oct 26th meeting, a "CNA Night" was planned, as was a donation auction to help support N.E.S.A, the education arm of the CNA.

## THE STRATFORD COIN CLUB

Due to the holiday on Oct. 11, the October meeting was held on Oct.18. The program of events scheduled included a film on Emanuel Hahn and an auction. Members were reminded in the newsletter, edited by Ken Wilmot, that the club's coin show would be held on Oct.31 at the Kiwanis Community Center.

## WATERLOO COIN SOCIETY

Members of the WCS were transported back to the classroom on Oct. 20th when teacher and WCS member Chris Boyer showed a special show on the RCM Canada 125 coin program.

In the newsletter, editor, Mike Hollingshead, commented on the success of the club's "mall promo days", their auctions, interesting meetings and excellent attendance (often 45-50 members).

Planned for the October meeting: Chris Boyer was bringing in a carload of school students. On a final note, the club's coin show is planned for Nov. 27 at The Rink in the Park.

**WE'D LOVE TO HEAR FROM YOUR CLUB!** Are you currently sending your club newsletter or a brief outline about what's going on at your club to the ONA editor. If not, put us on your mailing list. Even if you don't have a newsletter, let us know what's going on in your club. How's the hobby scene in your area? Write to the ONA Editor Jeff Fournier, P.O. Box 2111 Str. "A", Sudbury, Ont., P3A 4R8.



# MEMBERSHIP

The applications for membership which appeared in the Sept/Oct. issue of the Ontario Numismatist have been accepted.

C103 London Numismatic Society, c/o James A. Finch - Pres., London, Ont., N5Y 3A5

The following applications for membership have been received. If no written objection to these application is received, acceptance will appear in the next issue of the Ontario Numismatist.

1356 Chris Ladouceur, Ottawa, Ont.

1357 Bernard Kline, Halifax, N.S.

1358 Steven M. Playter, Brampton, Ontario

1359 Peter Kostyk, Niagara Falls, Ontario, L2G 7G4

C104 Canadian Association of Wooden Money Collectors - Southern Ontario Chapter, c/o Norm Belsten, Downsview, Ont., M3L 1K8

**HAVE YOU RECRUITED A NEW MEMBER YET THIS YEAR? DO YOUR PART TO HELP THE ONA GROW IN NUMBERS. SPREAD THE WORD ABOUT OUR ORGANIZATION.**

---

## ONA CLASSIFIEDS

The **"ONA CLASSIFIEDS"** will be a regular feature of this bulletin from now on...providing **YOU** want them. Send in your buy, sell, or trade ads c/o the ONA Editor, P.O. Box 2111 Stn. "A", Sudbury, Ont., P3A 4R8. Deadline for next issue is Jan.1/94. Please keep your ads to 3 or 4 lines.



**WANTED:** Canadian medallions, issued by coin clubs, municipalities, fraternities and so forths. What have you got? Also interested in Canadian municipal tokens (trade dollars). I'm looking to complete my collection of ONA medals, CNA medals and more. Also interested in Kenora 1936 Lake of the Woods bronze medal. Write with details, description, price. I will buy any and all if the price is reasonable (also will consider trades). Jeff Fournier, P.O. Box 2111 Stn. "A", Sudbury, Ont., P3A 4R8, phone: 705-560-7385.

**CANADIAN TRADE DOLLARS, MEDALLIONS, WOODEN MONEY ETC.,** Annual trade dollar subscription service. Trade dollar want lists accepted. Write for current list. Bonavita Ltd. Dept. ONA, P.O. Box 11447, Nepean, Ont., K2H 7J1.

---

London, Ontario issued a \$2 trade token this year to commemorate the city's founding 200 years ago by John Graves Simcoe. Graves is featured on the obverse and the historic Middlesex County Court House is on the reverse. They were minted in Nickel-bonded-steel, pure gold, antique-copper-plate, silver-plate and gold-plate. (Thanks to Tom Kostaluk for supplying the info.)



# A TOPICAL COLLECTION FROM VARIOUS NUMISMATIC FIELDS

By Jerry Remick

A topical collection of specimens from a number of numismatic fields, including coins, banknotes, tokens, medals, scrip, wooden nickels and other numismatic collectables, offers the collector a much wider choice of specimens for a topical collection than such a collection that is limited to pieces from just one of the above-mentioned numismatic fields. It's up to the collector to decide how many numismatic fields to include in a topical collection. A topical collection can be limited to say just metallic pieces and thus eliminates banknotes, scrip, wooden nickels and plastic tokens.



TRAINS

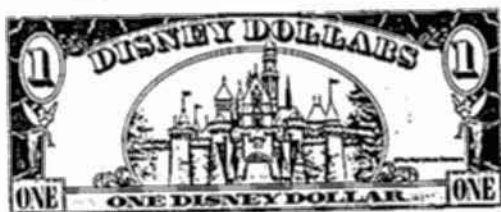

BUILDINGS

topic, a collector can derive a great many pleasant hours of looking through dealers' albums and junk boxes at any coin show or in a dealer's store.

A topical collection offers full freedom and is a pleasant contrast to the more rigid collecting of a date series or a series of coins or banknotes for a certain country or group of countries, as there are not holes to fill in, no checklists and probably few known rare pieces. It is always possible to find what will turn out to be a scarce or rare piece of one's topic in a dealer's junk box or for a modest price.



BOATS



INDIANS

The topic should interest the collector. It could be closely related to the collector's job or spare time interests. It is important to choose a topic that is not too large, if the collector wishes to collect pieces from a number of numismatic fields. Some suggestions for topics are: animals (perhaps too much material available), sea mammals, birds, fish, flowers, trees, mountains, farming scenes, industrial scenes, food, explorers, musical instruments, industries, musicians, medical doctors, men of science, men of learning, horse and buggies, bridges, trains, boats and ships, airplanes, automobiles, different materials used for numismatic pieces including all metals and alloys, or even postage stamps, coins/medals/tokens which depict reduced size reproductions of coins and medals. A topical collection, involving collectables from more than one numismatic field can give a great deal of satisfaction to the collector and also to the viewer of such a collection as

there is much contrast in the collection.

A collector can write an illustrated article on his/her topical collection. Such articles do not often appear in the ONA bulletin.



ANIMALS

# GREAT IDEAS

Like any editor, I'm constantly on the lookout for story ideas, bits and pieces of info. of relevance to the readers of this bulletin and so forth.

I'm always delighted to receive articles and story ideas from members and would encourage all to contribute something from time to time.

Sometimes, what stops a person from contributing is merely a lack of ideas, a perceived lack of qualifications or expertise, or a lack of time.

To help you, the members, and to encourage submissions to our newsletter, I will offer a few suggestions to you that may spark your interest, tickle your fancy and incite you to send something in.

Anyone can contribute something worthwhile and remember, the more that contribute, the better our bulletin will be!

## A FEW IDEAS

*If you're interested in writing an article for the "ONA NUMISMATIST", you might consider writing about some of the following items:*

*\*Canadian paper money (A general article on this topic would be appreciated)*

*\*A brief History of your club, or a paragraph or two (more if you wish) about what you do at your club meetings, why your club is successful, your auction, educational programs etc...*

*\*An autobiographical piece - how did you start collecting? Why do you collect? What do you collect?*

*\*A biographical piece - Do you know another collector of interest that you could do a story about?*

*\*Canadian decimals: choose one denomination such as the silver dollar, 5 cent piece, 25 cent piece etc... or perhaps one particular year of a particular denomination - write a story about it.*

*\*How to grade coins, store your coins, buying and selling coins - an article(s) covering the basics.*

*\*Foreign coins: Write a general article about foreign coins - where can you buy them? What are the various ways you can collect?*

*\*Books: Make a list of some of the best books available to coin collectors - which ones are essential for the serious student of numismatics - which ones do you think are the best.*

*\*Exonomia: A brief article about medals, tokens, masonic items, Canadian tire money etc...etc... the possibilities are endless here.*

*\*Interview your local dealer, or one you deal with often asking questions such as: which coins are hot? Which coins are not? Ask about recommended tips for buying and selling to him? What are his picks for the best performing coins in the near term/far term?*

If you don't feel confident about your writing abilities, do some research on one of the above topics or another of your choice. Put what you've found down on paper in a logical sequence and send it in to the editor who will write it up for you.

If you still don't have the inclination to write, keep your eyes peeled for good articles from other publications and send a copy in to the editor. Maybe information from it can be used for a future article. Send in your club newsletter, if you're not doing so already (you could also send in a copy of a newsletter, or info. in the newsletter, from a regional/specialty organization)

Send in info. about a recent numismatic discovery you've made.

Send in photos or photocopies of an interesting coin, medal or token.

Get involved, help out, share your thoughts, write a letter to the editor, but please contribute in some way. And thanks to all of those who have already done so!!